

 **IntesisBox**®  
FJ-RC-KNX-1i v1.2

User's Manual

Issue Date: 05/2018  
r1.4 eng

## © Intesis Software S.L.U. All Rights Reserved.

Information in this document is subject to change without notice. The software described in this document is furnished under a license agreement or Nondisclosure agreement. The software may be used only in accordance with the terms of those agreements. No part of this publication may be reproduced, stored in a retrieval system or transmitted in any form or any means electronic or mechanical, including photocopying and recording for any purpose other than the purchaser's personal use without the written permission of Intesis Software S.L.U.

Intesis Software S.L.U.  
Milà I Fontanals, 1 bis  
08700 Igualada  
Spain

### TRADEMARKS

All trademarks and trade names used in this document are acknowledged to be the copyright of their respective holders.

Gateway for integration of Fujitsu General Limited air conditioners into KNX TP-1 (EIB) control systems.

Application's Program Version: 1.1

Order Code: **FJ-RC-KNX-1i**

**INDEX**

1	Presentation.....	6
2	Connection.....	7
2.1	FJ-RC-KNX-1i with FGL Remote Controller.....	7
3	Configuration and setup.....	7
4	ETS Parameters.....	8
4.1	General dialog.....	9
4.1.1	Address in Fujitsu Remote Controller bus (3 wire).....	9
4.1.2	Fujitsu Error Type.....	9
4.1.3	Send READs for Control_ objects on bus recovery.....	10
4.1.4	Scene to load on bus recovery / startup.....	10
4.1.5	Disallow control from remote controller.....	10
4.1.6	Enable func "Control_ Lock Control Obj".....	11
4.1.7	Enable func "Operating Hours Counter".....	11
4.1.8	Enable object "Error Code [2byte]".....	12
4.1.9	Enable object "Error Text Code [14byte]".....	12
4.2	Mode Configuration dialog.....	13
4.2.1	Enable "Mode Cool/Heat" objects.....	13
4.2.2	Enable PID-Compat. Scaling Mode Objects (for Control).....	13
4.2.3	Enable use of + / - object for Mode.....	14
4.2.4	Enable use of bit-type Mode objects (for control).....	15
4.2.5	Enable use of bit-type Mode objects (for status).....	15
4.2.6	Enable use of Text object for Mode.....	16
4.3	Special Modes Configuration dialog.....	16
4.3.1	Enable use of ECONOMY mode (AC feature).....	17
4.3.2	Enable use of POWER mode.....	17
4.3.3	Enable use of ECONOMY mode.....	18
4.3.4	Enable use of ADDITIONAL HEATING mode.....	19
4.3.5	Enable use of ADDITIONAL COOLING mode.....	20
4.4	Fan Speed Configuration dialog.....	21
4.4.1	Available fanspeeds in Indoor Unit.....	21
4.4.2	DPT object type for fanspeed.....	21
4.4.3	Enable use of +/- object for Fan Speed.....	23
4.4.4	Enable "Fan Speed Man/Auto" objects (for Control and Status).....	24
4.4.5	Enable use of bit-type Fan Speed objects (for Control).....	24
4.4.6	Enable use of bit-type Fan Speed objects (for Status).....	24
4.4.7	Enable use of Text object for Fan Speed.....	24
4.5	Vanes Up-Down Configuration dialog.....	25
4.5.1	Indoor unit has U-D Vanes.....	25
4.5.2	Type of Vanes Control.....	26
4.5.3	Available U-D positions in Indoor Unit.....	26
4.5.4	DPT object type for Vanes Up-Down.....	27
4.5.5	Enable use of +/- object for Vanes U-D.....	28
4.5.6	Enable use of bit-type Vane U-D objects (for Control).....	29
4.5.7	Enable use of bit-type Vane U-D objects (for Status).....	29
4.5.8	Enable "Vanes U-D Swing" objects (for control and status).....	30
4.5.9	Enable use of Text object for Vane U-D.....	30
4.6	Vanes Left-Right Configuration dialog.....	31
4.6.1	Indoor unit has L-R Vanes.....	31
4.6.2	Type of Vanes Control.....	31
4.6.3	Available L-R positions in Indoor Unit.....	32
4.6.4	DPT object type for Vanes Left-Right.....	33
4.6.5	Enable use of +/- object for Vanes L-R.....	34
4.6.6	Enable use of bit-type Vane L-R objects (for Control).....	35
4.6.7	Enable use of bit-type Vane L-R objects (for Status).....	35
4.6.8	Enable "Vanes L-R Swing" objects (for control and status).....	35

4.6.9	Enable use of Text object for Vane L-R.....	36
4.7	Temperature Configuration dialog.....	37
4.7.1	Periodic sending of "Status_ AC Setp".....	37
4.7.2	Transmission of "Status_ AC Ambient Ref Temp".....	37
4.7.3	Enable use of +/- object for Setpoint Temp.....	38
4.7.4	Enable limits on Control_ Setpoint obj.....	38
4.7.5	Ambient temp. ref. is provided from KNX.....	39
4.8	Scene Configuration dialog.....	39
4.8.1	Enable use of scenes.....	40
4.8.2	Scenes can be stored from KNX bus.....	40
4.8.3	Enable use of bit objects for scene execution.....	41
4.8.4	Scene "x" preset.....	41
4.9	Switch-Off Timeouts Configuration dialog.....	43
4.9.1	Enable use of Open Window / Switch off timeout function.....	43
4.9.2	Enable use of Occupancy function.....	44
4.9.3	Enable use of SLEEP timeout.....	47
4.10	Binary Input "x" Configuration dialog.....	48
4.10.1	Enable use of Input "x".....	48
4.10.2	Contact type.....	48
4.10.3	Debounce time.....	48
4.10.4	Disabling function.....	49
4.10.5	Function.....	49
5	Specifications.....	57
6	AC Unit Types compatibility.....	58
7	Error Codes.....	59
7.1	RAC and VRF J-II / V-II / VR-II series.....	59
7.2	VRF V / S / J series.....	61
8	Appendix A – Communication Objects Table.....	62

# 1 Presentation



FJ-RC-KNX-1i allows a complete and natural integration of Fujitsu General Limited (FGL from now on) air conditioners with KNX control systems.

## Main features:

- Reduced dimensions and quick installation.
- Multiple objects for control and status (bit, byte, characters...) with KNX standard datapoint types.
- Status objects for every control available.
- Timeout for Open Window and Occupancy. Sleep function also available.
- Control of the AC unit based in the ambient temperature read by the own AC unit, or in the ambient temperature read by any KNX thermostat.
- AC unit can be controlled simultaneously by the wired remote control of the AC unit and by KNX.
- Total Control and Monitoring of the AC unit from KNX, including monitoring of AC unit's state of internal variables, running hours counter (for filter maintenance control), and error indication and error code.
- Up to 5 scenes can be saved and executed from KNX, fixing the desired combination of Operation Mode, Set Temperature, Fan Speed, Vane Position and Remote Controller Lock in any moment by using a simple switching.
- Four binary inputs for potential-free contacts provide the possibility to integrate many types of external devices. Also configurable from ETS, they can be used for switching, dimming, shutter/blind control, and more.

## 2 Connection

### Connection of the FJ-RC-KNX-1i to the AC indoor unit

The FJ-RC-KNX-1i can be connected directly to the RWB (1:Red, 2:White, 3:Black) bus of the indoor unit (No FGL remote controller -RC from Now on- connected in the RWB bus) or with the FGL RC. See connection diagram below.

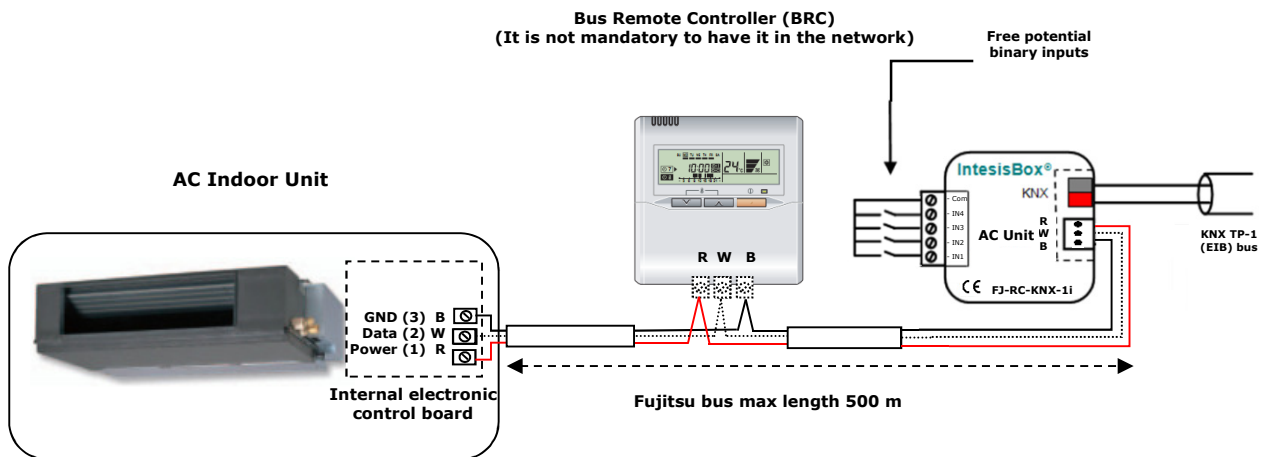

Figure 2.1 FJ-RC-KNX-1i connection diagrams

### 2.1 FJ-RC-KNX-1i with FGL Remote Controller

#### Connection of the FJ-RC-KNX-1i to the KNX bus:

Disconnect power of the KNX bus. Connect the FJ-RC-KNX-1i to the KNX TP-1 (EIB) bus using the KNX standard connector (red/grey) of the FJ-RC-KNX-1i, respect polarity.

Reconnect power of the KNX bus and mains power of the AC unit.

**⚠ Important:** Please, connect first the IntesisBox on the KNX bus and then to the AC unit. Afterwards, power the AC unit and wait 30 seconds for the unit and the IntesisBox to start communicating properly.

## 3 Configuration and setup

This is a fully compatible KNX device which must be configured and setup using standard KNX tool ETS.

ETS database for this device can be downloaded from:

[https://www.intesisbox.com/intesis/product/media/intesisbox\\_fj-rc-knx-1i\\_ets-database.zip](https://www.intesisbox.com/intesis/product/media/intesisbox_fj-rc-knx-1i_ets-database.zip)

Please consult the README.txt file, located inside the downloaded zip file, to find instructions on how to install the database.

**⚠ Important:** Do not forget to select the correct settings of AC indoor unit being connected to the FJ-RC-KNX-1i. This is in "Parameters" of the device in ETS.

## 4 ETS Parameters

When imported to the ETS software for the first time, the gateway shows the following default parameter configuration:

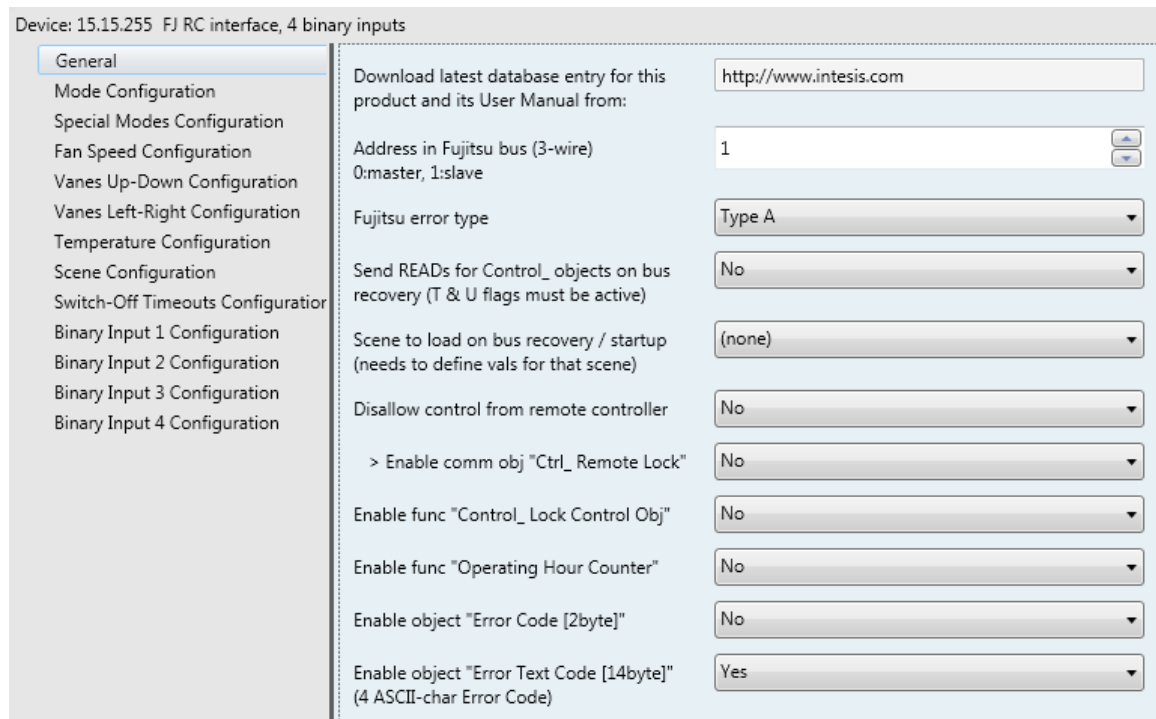

**Figure 4.1** Default parameter configuration

With this configuration it's possible to send On/Off (*Control\_ On/Off*), change the AC Mode (*Control\_ Mode*), the Fan Speed (*Control\_ Fan Speed*) and also the Setpoint Temperature (*Control\_ Setpoint Temperature*). The Status\_ objects, for the mentioned Control\_ objects, are also available to use if needed. Also objects *Status\_ AC Ambient Ref Temp* and *Status\_ Error/Alarm* are shown.

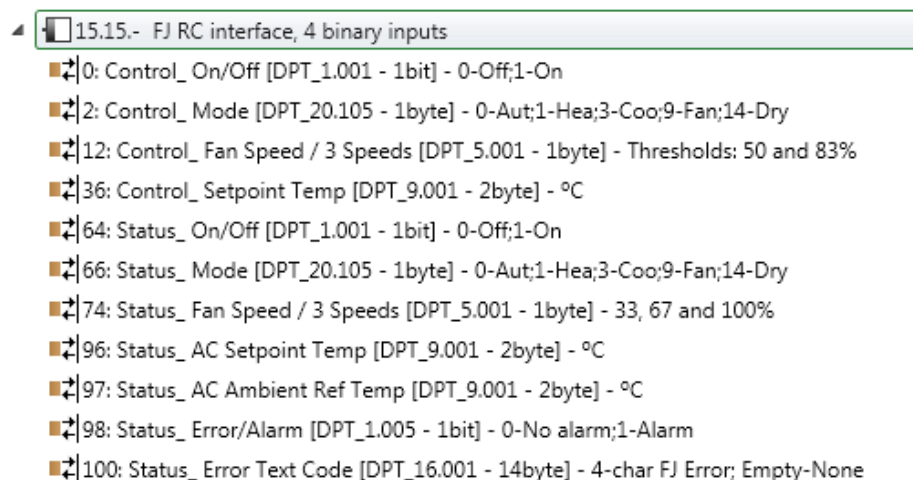

**Figure 4.2** Default communication objects

## 4.1 General dialog

Inside this parameter's dialog it is possible to activate or change the parameters shown in the Figure 4.1.

The first field shows the URL where to download the database and the user manual for the product. (Currently: <http://www.intesisbox.com>)

### 4.1.1 Address in Fujitsu Remote Controller bus (3 wire)

Fujitsu dual remote controller function setting. 0: master, 1: slave (default).

This parameter is used to select the function our gateway will have in the RWB RC-bus.

- If set to **"0"** the gateway will act as a **master** in the RC-bus. (No BRC present, or BRC set as slave).
- If set to **"1"** the gateway will act as a **slave** in the RC-bus. (BRC present set as master).

**Figure 4.3** Parameter detail

**⚠ Important:** After changing this parameters value and downloading to the gateway, it is required to perform a power cycle of the FGL system to apply the changes in the systems active runtime memory.

### 4.1.2 Fujitsu Error Type

This parameter defines the type of FGL unit you have and the associated error codes. Please, check table below which value you have to use depending on the AC system type you have.

**Figure 4.4** Parameter detail

AC System Type	Error Type
RAC Non inverter models RAC inverter models	Type A
VRF V / S / J	Type A
RAC inverter model G* series VRF J-II / V-II / VR-II	Type B

**Table 4.1** Parameter detail

### 4.1.3 Send READs for Control\_ objects on bus recovery

When this parameter is enabled, FJ-RC-KNX-1i will send READ telegrams for the group addresses associated on its *Control\_* objects on bus recovery or application reset/start-up.

- If set to **"No"** the gateway will not perform any action.
- If set to **"Yes"** all *Control\_* objects with both Transmit (**T**) and Update (**U**) flags enabled will send READs and their values will be updated with the response when received.

Send READs for Control\_ objects on bus recovery (T & U flags must be active) Yes

> Delay before sending READs (sec) 10

**Figure 4.5** Parameter detail

➤ Delay before sending READs (sec):

With this parameter, a delay can be configured between 0 and 30 seconds for the READs sent by the *Control\_* objects. This is to give time enough to other KNX devices on the bus to start-up before sending the READs.

### 4.1.4 Scene to load on bus recovery / startup

This parameter executes a selected scene on bus recovery or startup, only if the selected scene has an enabled preset or values previously saved from KNX bus (see 4.8 for more information).

If the gateway is disconnected from the indoor unit the scene will not be applied, even when connecting to the indoor unit again.

Scene to load on bus recovery / startup (needs to define vals for that scene) scene 2

**Figure 4.6** Parameter detail

### 4.1.5 Disallow control from remote controller

This parameter allows:

- 1- Having the remote controller always locked, or
- 2- Decide through a new communication object if the RC is locked or not. (Default)

- If set to **"Yes"** all the actions performed through the remote controller will be disabled.
- If set to **"No"** the remote controller will work as usually. It also appears a new parameter and the communication object *Control\_ Lock Remote Control*.

■ ↕ 42: Control\_ Lock Remote Control [DPT\_1.002 - 1bit] - 0-Unlock;1-Lock  
 ■ ↕ 101: Status\_ Lock Remote Control [DPT\_1.002 - 1bit] - 0-Unlocked;1-Locked

Disallow control from remote controller	no
> Enable comm obj "Ctrl_ Remote Lock"	yes

**Figure 4.7** Communication Object and parameter detail

➤ Enable comm obj "Ctrl\_ Remote Lock":

If set to **"No"** the object will not be shown. (Default).

If set to **"Yes"** the *Control\_ Lock Remote Control* object will appear.

- When a **"1"** value is sent to this communication object, the remote controller is locked. To be unlocked a **"0"** value must be sent. *The gateway remembers the last value received even if a KNX bus reset/failure happens.*

**⚠ Important:** *If an initial scene is enabled and it has as Value for Remote Lock (unchanged) or unlocked, this would unlock the remote controller because the initial scene has priority over the Control\_ Lock Remote Control communication object.*

#### 4.1.6 Enable func "Control\_ Lock Control Obj"

This parameter shows/hide the *Control\_ Lock Control Obj* communication object which, depending on the sent value, locks or unlocks ALL the *Control\_* communication objects except itself. It also shows/hide the *Status\_ Lock Control Obj*.

- 43 Control\_ Lock Control Objects [DPT\_1.002 - 1bit] - 0-Unlocked;1-Locked
- 104 Status\_ Lock Control Objects [DPT\_1.002 - 1bit] - 0-Unlocked;1-Locked

- If set to **"No"** the object will not be shown.
- If set to **"Yes"** the *Control\_ Lock Control Objects* object will appear.
  - When a **"1"** value is sent to this communication object, all the *Control\_* objects will be locked. To unlock a **"0"** value must be sent, as the gateway remembers the last value received even if a KNX bus reset/failure happens.

#### 4.1.7 Enable func "Operating Hours Counter"

This parameter shows/hides the *Status\_ Operation Hour Counter* communication object which counts the number of operating hours for the FJ-RC-KNX-1i.

- 107 Status\_ Operation Hour Counter [DPT\_7.001 - 2byte] - Number of operating hours

- If set to **"No"** the object will not be shown.

- If set to **"Yes"** the *Status\_ Operation Hour Counter* object will appear.
  - This object can be read and sends its status every time an hour is counted. The gateway keeps that count in memory and the status is sent also after a KNX bus reset/failure. Although this object is marked as a *Status\_* object it also can be written to update the counter when needed. To reset the counter should be written a **"0"** value.
  - ⚠ **Important:** This object comes by default without the write **(W)** flag activated. If is necessary to write on it, this flag must be activated.
  - ⚠ **Important:** This object will also return its status, every time a value is written, only if it's different from the existing one.
  - ⚠ **Important:** If the stored value is 0 hours, the gateway will not send the status to KNX.

#### 4.1.8 Enable object "Error Code [2byte]"

This parameter shows/hides the *Status\_ Error Code* communication object which shows the indoor unit errors, if occurred, in numeric format.

📡 99 Status\_ Error Code [2byte] - 0-No error /Any other see man.

- If set to **"No"** the object will not be shown.
- If set to **"Yes"** the *Status\_ Error Code [2byte]* object will appear.
  - This object can be read and also sends the indoor unit error, if occurred, in numeric format. If a **"0"** value is shown that means No error.

#### 4.1.9 Enable object "Error Text Code [14byte]"

This parameter shows/hides the *Status\_ Error Text Code* communication object which shows the indoor unit errors, if occurred, in text format.

📡 100 Status\_ Error Text Code [DPT\_16.001 - 14byte] - 3-charFJ Error; Empty-None

- If set to **"No"** the object will not be shown.
- If set to **"Yes"** the *Status\_ Error Text Code* object will appear.
  - This object can be read and also sends the indoor unit error, if occurred, in text format. The errors shown have the same format as at the remote controller and at the error list from the indoor unit manufacturer. If the object's value is empty that means No error.

## 4.2 Mode Configuration dialog

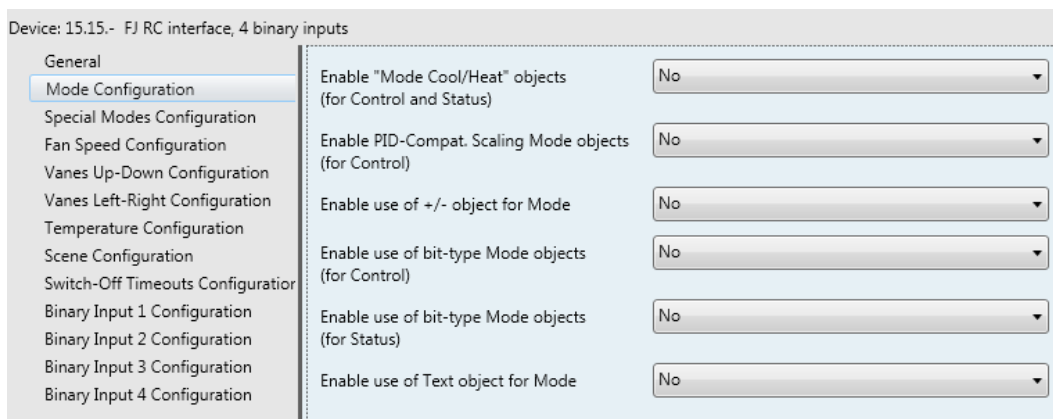

**Figure 4.8** Default Mode Configuration dialog

All the parameters in this section are related with the different mode properties and communication objects.

### 4.2.1 Enable "Mode Cool/Heat" objects

This parameter shows/hides the *Control\_* and *Status\_ Mode Cool/Heat* communication objects.

➡ 3 *Control\_ Mode Cool/Heat* [DPT\_1.100 - 1bit] - 0-Cool;1-Heat  
➡ 67 *Status\_ Mode Cool/Heat* [DPT\_1.100 - 1bit] - 0-Cool;1-Heat

- If set to **"No"** the objects will not be shown.
- If set to **"Yes"** the *Control\_* and *Status\_ Mode Cool/Heat* objects will appear.
  - When a **"1"** value is sent to the *Control\_* communication object, **Heat mode** will be enabled in the indoor unit, and the *Status\_* object will return this value.
  - When a **"0"** value is sent to the *Control\_* communication object, **Cool mode** will be enabled in the indoor unit, and the *Status\_* object will return this value.

### 4.2.2 Enable PID-Compat. Scaling Mode Objects (for Control)

This parameter shows/hides the *Control\_ Mode Cool & On* and *Control\_ Mode Heat & On* communication objects.

➡ 4 *Control\_ Mode Cool & On* [DPT\_5.001 - 1byte] - 0%-Off;0.1%-100%-On+Cool  
➡ 5 *Control\_ Mode Heat & On* [DPT\_5.001 - 1byte] - 0%-Off;0.1%-100%-On+Heat

- If set to **"No"** the objects will not be shown.

- If set to **"Yes"** the *Control\_ Mode Cool & On* and *Control\_ Mode Heat & On* objects will appear.
    - These objects provide compatibility with those KNX thermostats that control the demand of heating or cooling by using scaling (percentage) objects. In these thermostats, the percentage demand is meant to be applied on a fluid valve of the heating / cooling system.
    - FJ-RC-KNX-1i device does not provide individual control on the internal parts of the indoor unit (as can be its compressor, refrigerant valves, etc.). Rather, it provides the same level of control as a (user) remote controller.
    - Objects "Control\_ Mode Cool & On" and "Control\_ Mode Heat & On" intend to bring compatibility between thermostats oriented to the control of custom heating / cooling systems and ready-made AC indoor units, by applying the following logic:
      - Whenever a Non-zero value (>0%) is received at "Control\_ Mode Cool & On", indoor unit will switch On in COOL mode.
      - Whenever a Non-zero value (>0%) is received at "Control\_ Mode Heat & On", indoor unit will switch On in HEAT mode.
        - Latest updated object will define the operating mode
      - Indoor unit will switch off only when both objects become zero (0%) – or when an OFF is requested at object "0. On/Off [DPT\_1.001 - 1bit]"
- \* **Important:** *These objects function is only to send On/Off and Cool/Heat to the indoor unit. The PID (Inverter system) is calculated by the indoor unit itself. Please consider introducing an appropriate PID configuration to the external KNX thermostat to not interfere the indoor unit PID.*

#### 4.2.3 Enable use of + / - object for Mode

This parameter shows/hides the *Control\_ Mode +/-* communication object which lets change the indoor unit mode by using two different datapoint types.

■ 11 Control\_ Mode -/+ [DPT\_1.007 - 1bit] - 0-Decrease;1-Increase

- If set to **"No"** the object will not be shown.
- If set to **"Yes"** the *Control\_ Mode +/-* object and a new parameter will appear.

Enable use of +/- object for Mode	yes
> DPT type for +/- Mode Object	0-Up / 1-Down [DPT_1.008]

**Figure 4.9** Parameter detail

➤ DPT type for +/- Mode Object

This parameter lets choose between the datapoints **0-Up / 1-Down [DPT\_1.008]** and **0-Decrease / 1-Increase [DPT\_1.007]** for the *Control\_Mode* +/- object.

The sequence followed when using this object is shown below:



- Up / Increase
- Down / Decrease

⚠ **Important:** Read the documentation of your indoor unit to check if it has HEAT mode available.

#### 4.2.4 Enable use of bit-type Mode objects (for control)

This parameter shows/hides the bit-type *Control\_Mode* objects.

- ↕ 6 Control\_Mode Auto [DPT\_1.002 - 1bit] - 1-Set AUTO mode
- ↕ 7 Control\_Mode Heat [DPT\_1.002 - 1bit] - 1-Set HEAT mode
- ↕ 8 Control\_Mode Cool [DPT\_1.002 - 1bit] - 1-Set COOL mode
- ↕ 9 Control\_Mode Fan [DPT\_1.002 - 1bit] - 1-Set FAN mode
- ↕ 10 Control\_Mode Dry [DPT\_1.002 - 1bit] - 1-Set DRY mode

- If set to **"No"** the objects will not be shown.
- If set to **"Yes"** the *Control\_Mode* objects for Auto, Heat, Cool, Fan and Dry will appear. To activate a mode by using these objects a **"1"** value has to be sent.

#### 4.2.5 Enable use of bit-type Mode objects (for status)

This parameter shows/hides the bit-type *Status\_Mode* objects.

- ↕ 68 Status\_Mode Auto [DPT\_1.002 - 1bit] - 1-AUTO mode is active
- ↕ 69 Status\_Mode Heat [DPT\_1.002 - 1bit] - 1-HEAT mode is active
- ↕ 70 Status\_Mode Cool [DPT\_1.002 - 1bit] - 1-COOL mode is active
- ↕ 71 Status\_Mode Fan [DPT\_1.002 - 1bit] - 1-FAN mode is active
- ↕ 72 Status\_Mode Dry [DPT\_1.002 - 1bit] - 1-DRY mode is active

- If set to **"No"** the objects will not be shown.
- If set to **"Yes"** the *Status\_Mode* objects for Auto, Heat, Cool, Fan and Dry will appear. When enabled, a mode will return a **"1"** through its bit-type object.

## 4.2.6 Enable use of Text object for Mode

This parameter shows/hides the *Status\_ Mode Text* communication object.

73 Status\_ Mode Text [DPT\_16.001 - 14byte] - ASCII String

- If set to **"No"** the object will not be shown.
- If set to **"Yes"** the *Status\_ Mode Text* object will appear. Also, in the parameters, will be shown five text fields, one for each mode, that will let modify the text string displayed by the *Status\_ Mode Text* when changing mode.

> String when mode is AUTO	AUTO
> String when mode is HEAT (if available)	HEAT
> String when mode is COOL	COOL
> String when mode is FAN	FAN
> String when mode is DRY	DRY

Figure 4.10 Parameter detail

## 4.3 Special Modes Configuration dialog

Device: 15.15.- FJ RC interface, 4 binary inputs

General	Enable use of "ECONOMY" mode (AC feature)	No
Mode Configuration	Enable use of POWER mode	No
Special Modes Configuration	Enable use of ECONOMY mode	No
Fan Speed Configuration	Enable use of ADDITIONAL HEATING mode	No
Vanes Up-Down Configuration	Enable use of ADDITIONAL COOLING mode	No
Vanes Left-Right Configuration		
Temperature Configuration		
Scene Configuration		
Switch-Off Timeouts Configuration		
Binary Input 1 Configuration		
Binary Input 2 Configuration		
Binary Input 3 Configuration		
Binary Input 4 Configuration		

Figure 4.11 Default Special Modes Configuration dialog

The Special Modes can be parameterized through the ETS parameters dialog and they can be used to give extra functionality.

**⚠ Important:** When executing any of the Special Modes the real state of the indoor unit will NOT be shown in KNX.



**⚠ Important:** When the predefined time for the Special Mode is finished or a "0" value is sent to stop it; the previous state will be recovered.

**⚠ Important:** If a value concerning On/Off, Mode, Fan Speed or Setpoint Temperature is received from KNX while any Special Mode is running ("1"), the Special Mode will stop and the previous state will be recovered. The value received will be also applied then.

**⚠ Important:** If a value concerning On/Off, Mode, Fan Speed or Setpoint Temperature is modified through the remote controller, the Special Mode will stop *WITHOUT* recovering the previous state. Then the real indoor unit state will be shown in KNX including the new value received through the remote controller.

#### 4.3.1 Enable use of ECONOMY mode (AC feature)



This parameter shows/hides the *Control\_ Economy* and *Status\_ Economy* communication objects. This communication object is using the Economy function provided by the AC unit itself. Please refer to your user manual for more information on this function.

 1 Control\_ Economy [DPT\_1.002 - 1bit] - 1-Set ECONOMY  
 65 Status\_ Economy [DPT\_1.002 - 1bit] - 1-ECONOMY is active

- If set to **"No"** the objects will not be shown.
  - If set to **"Yes"** the *Control\_ Economy* and *Status\_ Economy* objects and new parameters will appear.
    - When a **"1"** value is sent to the *Control\_* communication object, Economy will be enabled, and the *Status\_* object will return this value.
    - When a **"0"** value is sent to the *Control\_* communication object, Economy will be disabled, and the *Status\_* object will return this value.
- ⚠ Important:** This mode will *ONLY* work if the indoor unit is both turned on and in a Heat, Cool, Auto-Heat or Auto-Cool Mode.

#### 4.3.2 Enable use of POWER mode

This parameter shows/hides the *Control\_ Power Mode* and *Status\_ Power Mode* communication objects. The Power Mode lets change the Setpoint Temperature and the Fan Speed within a given period of time.

 44 Control\_ Power Mode [DPT\_1.010 - 1bit] - 0-Stop;1-Start  
 103 Status\_ Power Mode [DPT\_1.001 - 1bit] - 0-Off;1-On

- If set to **"No"** the objects will not be shown.
- If set to **"Yes"** the *Control\_ Power Mode* and *Status\_ Power Mode* objects and new parameters will appear.

Enable use of POWER mode	Yes
> Action time for this mode (minutes)	30
> Setpoint delta increase (HEAT) or decrease (COOL) (°C)	2.0 °C
> Fan Speed for this mode	FAN SPEED 3

**Figure 4.12** Parameter detail

- When a "1" value is sent to the *Control\_* communication object Power Mode will be enabled, and the *Status\_* object will return this value.
- When a "0" value is sent to the *Control\_* communication object, Power Mode will be disabled, and the *Status\_* object will return this value.

**⚠ Important:** This mode will ONLY work if the indoor unit is both turned on and in a Heat, Cool, Auto-Heat or Auto-Cool Mode.

➤ Action time for this mode (minutes):

Duration of Power Mode, in minutes, once started.

➤ Setpoint delta increase (HEAT) or decrease (COOL) – in Celsius:

Number of degrees Celsius that will increase in Heat Mode, or decrease in Cool Mode, while in Power Mode.

➤ Fan Speed for this mode:

Fan Speed that will be set in the unit while in Power Mode.

### 4.3.3 Enable use of ECONOMY mode

This parameter shows/hides the *Control\_ Econo Mode* and *Status\_ Econo Mode* communication objects. The Econo Mode lets change the Setpoint Temperature and the Fan Speed within a given period of time.

- 45 Control\_ Econo Mode [DPT\_1.010 - 1bit] - 0-Stop;1-Start
- 104 Status\_ Econo Mode [DPT\_1.001 - 1bit] - 0-Off;1-On

- If set to "no" the objects will not be shown.
- If set to "yes" the *Control\_ Econo Mode* and *Status\_ Econo Mode* objects and new parameters will appear.

- When a "1" value is sent to the *Control\_* communication object, EconoMode will be enabled, and the *Status\_* object will return this value.
- When a "0" value is sent to the *Control\_* communication object, EconoMode will be disabled, and the *Status\_* object will return this value.

⚠ **Important:** This mode will ONLY work if the indoor unit is both turned on and in a Heat, Cool, Auto-Heat or Auto-Cool Mode.

➤ Action time for this mode (minutes):

Duration of EconoMode, in minutes, once started.

➤ Setpoint delta increase (HEAT) or decrease (COOL) – in Celsius:

Number of degrees Celsius that will increase in Heat Mode, or decrease in Cool Mode, while in EconoMode.

➤ Fan Speed for this mode:

Fan Speed that will be set in the unit while in EconoMode.

#### 4.3.4 Enable use of ADDITIONAL HEATING mode

This parameter shows/hides the *Control\_ Start Additional Heat Mode* and *Status\_ Additional Heat Mode* communication objects. The Additional Heating Mode lets change the Setpoint Temperature and the Fan Speed within a given period of time.

■ ↕ 46 Control\_ Additional Heat [DPT\_1,010 - 1bit] - 0-Stop;1-Start  
 ■ ↕ 105 Status\_ Additional Heat [DPT\_1,001 - 1bit] - 0-Off;1-On

Enable use of ADDITIONAL HEATING mode	Yes
> Action time for this mode (minutes)	30
> Setpoint temp for this mode (°C)	30 °C
> Fan Speed for this mode	FAN SPEED AUTO

**Figure 4.13** Communication object and parameter detail

- If set to "No" the objects will not be shown.
- If set to "Yes" the *Control\_ Start Additional Heat Mode* and *Status\_ Additional Heat Mode* objects and new parameters will appear.
  - When a "1" value is sent to the *Control\_* communication object, Additional Heating Mode will be enabled, and the *Status\_* object will return this value.

- When a "0" value is sent to the *Control\_* communication object, Additional Heating Mode will be disabled, and the *Status\_* object will return this value.

**⚠ Important:** This mode will ALWAYS turn on the indoor unit in Heat mode.

➤ Action time for this mode (minutes):

Duration of Additional Heating Mode, in minutes, once started.

➤ Setpoint temp for this mode (°C):

Setpoint temperature that will be applied while in Additional Heating Mode.

➤ Fan Speed for this mode:

Fan Speed that will be set in the unit while in Additional Heating Mode.

### 4.3.5 Enable use of ADDITIONAL COOLING mode

This parameter shows/hides the *Control\_ Start Additional Cool Mode* and *Status\_ Additional Cool Mode* communication objects. The Additional Heating Mode lets change the Setpoint Temperature and the Fan Speed within a given period of time.

- ➡ 47 Control\_ Additional Cool [DPT\_1.010 - 1bit] - 0-Stop;1-Start
- ➡ 106 Status\_ Additional Cool [DPT\_1.001 - 1bit] - 0-Off;1-On

Enable use of ADDITIONAL HEATING mode: Yes

> Action time for this mode (minutes): 30

> Setpoint temp for this mode (°C): 30 °C

> Fan Speed for this mode: FAN SPEED AUTO

**Figure 4.14** Communication object and parameter detail

- If set to "No" the objects will not be shown.
- If set to "Yes" the *Control\_ Start Additional Cool Mode* and *Status\_ Additional Cool Mode* objects and new parameters will appear.
  - When a "1" value is sent to the *Control\_* communication object, Additional Cooling Mode will be enabled, and the *Status\_* object will return this value.
  - When a "0" value is sent to the *Control\_* communication object, Additional Cooling Mode will be disabled, and the *Status\_* object will return this value.

**⚠ Important:** This mode will ALWAYS turn on the indoor unit in Cool mode.

- Action time for this mode (minutes):  
Duration of Additional Cooling Mode, in minutes, once started.
- Setpoint temp for this mode (°C):  
Setpoint temperature that will be applied while in Additional Cooling Mode.
- Fan Speed for this mode:  
Fan Speed that will be set in the unit while in Additional Cooling Mode.

#### 4.4 Fan Speed Configuration dialog

Device: 15.15.- FJ RC interface, 4 binary inputs

General	Available fanspeeds in Indoor Unit (see docum. for your indoor unit)	3
Mode Configuration	DPT object type for fanspeed	Scaling [DPT_5.001]
Special Modes Configuration	Enable use of +/- object for Fan Speed	No
Fan Speed Configuration	Enable "Fan Speed Man/Auto" objects (for Control and Status)	No
Vanes Up-Down Configuration	Enable use of bit-type Fan Speed objects (for Control)	No
Vanes Left-Right Configuration	Enable use of bit-type Fan Speed objects (for Status)	No
Temperature Configuration	Enable use of Text object for Fan Speed	No
Scene Configuration		
Switch-Off Timeouts Configurati		
Binary Input 1 Configuration		
Binary Input 2 Configuration		
Binary Input 3 Configuration		
Binary Input 4 Configuration		

**Figure 4.15** Default Fan Speed Configuration dialog

All the parameters in this section are related with the Fan Speed properties and communication objects.

##### 4.4.1 Available fanspeeds in Indoor Unit

This parameter needs to be fixed according to you indoor unit capacity. Please check your indoor unit user manual and introduce the right number of fanspeeds.

Available fanspeeds in Indoor Unit  
(see docum. for your indoor unit)

3

**Figure 4.16** Parameter detail

##### 4.4.2 DPT object type for fanspeed

With this parameter is possible to change de DPT for the *Control\_Fan Speed* and *Status\_Fan Speed* byte-type communication objects. Datapoints Scaling (DPT\_5.001) and Enumerated (DPT\_5.010) can be selected.

**⚠ Important:** *The communication objects shown in this section may be different depending on the number of fan speeds available, although they all share the same communication object number.*

- When **“Enumerated [DPT 5.010]”** is selected, *Control\_ Fan Speed* and *Status\_ Fan Speed* communication objects for this DPT will appear.

- ↕ 12 Control\_ Fan Speed / 3 Speeds [DPT\_5.010 - 1byte] - Speed values: 1,2,3
- ↕ 74 Status\_ Fan Speed / 3 Speeds [DPT\_5.010 - 1byte] - Speed Values: 1,2,3
  
- ↕ 12 Control\_ Fan Speed / 4 Speeds [DPT\_5.010 - 1byte] - Speed values: 1,2,3,4
- ↕ 74 Status\_ Fan Speed / 4 Speeds [DPT\_5.010 - 1byte] - Speed Values: 1,2,3,4

The first fan speed will be selected if a **“1”** is sent to the *Control\_* object. The second one will be selected sending a **“2”**; the third one will be selected sending a **“3”**; the fourth one selecting **“4”**

The *Status\_* object will always return the value for the fan speed selected.

**⚠ Important:** If a **“0”** value is sent to the *Control\_* object, the minimum fan speed will be selected. If a value bigger than **“4”** is sent to the *Control\_* object, then the maximum fan speed will be selected.

- When **“Scaling [DPT 5.001]”** is selected, *Control\_ Fan Speed* and *Status\_ Fan Speed* communication objects for this DPT will appear.

- ↕ 12 Control\_ Fan Speed / 3 Speeds [DPT\_5.001 - 1byte] - Thresholds: 50 and 83%
- ↕ 74 Status\_ Fan Speed / 3 Speeds [DPT\_5.001 - 1byte] - 33, 67 and 100%
  
- ↕ 12 Control\_ Fan Speed / 4 Speeds [DPT\_5.001 - 1byte] - Thresholds: 38, 63 and 88%
- ↕ 74 Status\_ Fan Speed / 4 Speeds [DPT\_5.001 - 1byte] - 25, 50, 75 and 100%

Table next shows the range of values that can be sent through the *Control\_* object and the value returned by the *Status\_* object.

	Fan Speed 1	Fan Speed 2	Fan Speed 3
Control_	0% - 49%	50% - 82%	83% - 100%
Status_	33%	67%	100%

	Fan Speed 1	Fan Speed 2	Fan Speed 3	Fan Speed 4
Control_	0% - 37%	38% - 62%	63% - 87%	88% - 100%
Status_	25%	50%	75%	100%

**⚠ Important:** Read the documentation of your indoor unit to check how many fan speeds are available.

### 4.4.3 Enable use of +/- object for Fan Speed

This parameter shows/hides the *Control\_ Fan Speed +/-* communication object which lets increase/decrease the indoor unit fan speed by using two different datapoint types.

■ ↗ 18 Control\_ Fan Speed +/- [DPT\_1.007 - 1bit] - 0-Decrease;1-Increase

- If set to **"No"** the object will not be shown.
- If set to **"Yes"** the *Control\_ Fan Speed +/-* object and a new parameter will appear.

Enable use of +/- object for Fan Speed	Yes
> DPT type for +/- Fan Speed object	0-Decrease / 1-Increase [DPT_1.007]
> Does +/- sequence include fan speed AUTO?	No
> Rollover Speed at upper/lower limit (when controlling with +/- obj)	Yes

**Figure 4.17** Parameter detail

#### ➤ DPT type for +/- Fan Speed Object

This parameter lets choose between the datapoints **0-Up / 1-Down [DPT\_1.008]** and **0-Decrease / 1-Increase [DPT\_1.007]** for the *Control\_ Fan Speed +/-* object.

#### ➤ Does +/- sequence include fan speed Auto?

This parameter includes or excludes the auto mode for the fan speed in the list of available speeds.

#### ➤ Roll-over Speed at upper/lower limit

This parameter lets choose if roll-over will be enabled (**"Yes"**) or disabled (**"No"**) for the *Control\_ Fan Speed +/-* object.

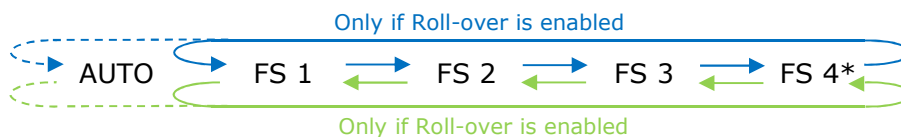

- Up / Increase
- Down / Decrease
- \* If available

#### 4.4.4 Enable "Fan Speed Man/Auto" objects (for Control and Status)

This parameter shows/hides the bit-type *Control\_ Fan Speed Man/Auto* and the *Status\_ Fan Speed Man/Auto* objects.

- ↕ 13 Control\_ Fan Speed Man/Auto [DPT\_1.002 - 1bit] - 0-Manual; 1-Auto
- ↕ 75 Status\_ Fan Speed Man/Auto [DPT\_1.002 - 1bit] - 0-Manual;1-Auto

#### 4.4.5 Enable use of bit-type Fan Speed objects (for Control)

This parameter shows/hides the bit-type *Control\_ Fan Speed* objects.

- ↕ 14 Control\_ Fan Speed 1 [DPT\_1.002 - 1bit] - 1-Set Fan Speed 1
- ↕ 15 Control\_ Fan Speed 2 [DPT\_1.002 - 1bit] - 1-Set Fan Speed 2
- ↕ 16 Control\_ Fan Speed 3 [DPT\_1.002 - 1bit] - 1-Set Fan Speed 3
- ↕ 17 Control\_ Fan Speed 4 [DPT\_1.002 - 1bit] - 1-Set Fan Speed 4\*

\* Only available if the AC unit has 4 fan speeds.

- If set to **"No"** the objects will not be shown.
- If set to **"Yes"** the *Control\_ Fan Speed* objects for Speed 1, Speed 2 and Speed 3 will appear. To activate a Fan Speed by using these objects a **"1"** value has to be sent.

#### 4.4.6 Enable use of bit-type Fan Speed objects (for Status)

This parameter shows/hides the bit-type *Status\_ Fan Speed* objects.

- ↕ 76 Status\_ Fan Speed 1 [DPT\_1.002 - 1bit] - 1-Fan in Speed 1
- ↕ 77 Status\_ Fan Speed 2 [DPT\_1.002 - 1bit] - 1-Fan in Speed 2
- ↕ 78 Status\_ Fan Speed 3 [DPT\_1.002 - 1bit] - 1-Fan in Speed 3
- ↕ 79 Status\_ Fan Speed 4 [DPT\_1.002 - 1bit] - 1-Fan in Speed 4\*

\* Only available if the AC unit has 4 fan speeds.

- If set to **"No"** the objects will not be shown.
- If set to **"Yes"** the *Status\_ Fan Speed* objects for Speed 1, Speed 2, Speed 3 and Speed 4 (if available) will appear. When a Fan Speed is enabled, a **"1"** value is returned through its bit-type object.

#### 4.4.7 Enable use of Text object for Fan Speed

This parameter shows/hides the *Status\_ Fan Speed Text* communication object.

- ↕ 80 Status\_ Fan Speed Text [DPT\_16.001 - 14byte] - ASCII String

- If set to **"No"** the object will not be shown.
- If set to **"Yes"** the *Status\_ Fan Speed Text* object will appear. Also, in the parameters, will be shown five text fields, one for each Fan Speed, that will let modify the text string displayed by the *Status\_ Fan Speed Text* when changing a fan speed.

ASCII strings shown in comm object "Status_ Fan Speed Text"	<< 14-byte string values >>
> String when fan speed is AUTO	AUTO
> String when fan speed is 1	SPEED 1
> String when fan speed is 2	SPEED 2
> String when fan speed is 3	SPEED 3
> String when fan speed is 4 (if available)	SPEED 4

Figure 4.18 Parameter detail

## 4.5 Vanes Up-Down Configuration dialog

Device: 15.15.- FJ RC interface, 4 binary inputs

General	Indoor unit has U-D Vanes (see docum. for your indoor unit)	Yes
Mode Configuration	Type of Vanes Control	Position
Special Modes Configuration	Available U-D positions in Indoor Unit (see docum. for your indoor unit)	0 (only Swing)
Fan Speed Configuration	Enable "Vanes U-D Swing" objects (for Control and Status)	Yes
Vanes Up-Down Configuration		
Vanes Left-Right Configuration		
Temperature Configuration		
Scene Configuration		
Switch-Off Timeouts Configuration		
Binary Input 1 Configuration		
Binary Input 2 Configuration		
Binary Input 3 Configuration		
Binary Input 4 Configuration		

Figure 4.19 Vanes Up-Down Configuration dialog

All the parameters in this section are related with the Vanes Up-Down properties and communication objects.

### 4.5.1 Indoor unit has U-D Vanes

This parameter lets choose if the unit has Up-Down Vanes available or not.

Indoor unit has U-D Vanes (see docum. for your indoor unit)	Yes
---	-----

Figure 4.20 Parameter detail

- If set to **"No"** all the parameters and communication objects for the Up-Down Vanes will not be shown.

- If set to **"Yes"** all the parameters and communication objects (if enabled in the parameters dialog) for the Up-Down Vanes will be shown.

**⚠ Important:** Read the documentation of your indoor unit to check if Up-Down Vanes are available.

## 4.5.2 Type of Vanes Control

This parameter lets choose if the unit uses a step control no the vanes position or directly a position indication.



Type of Vanes Control

**Figure 4.21** Parameter detail

- If set to **"Step"** only the communication objects only for SWING and STEP will be shown.

- 24: Control\_Vanes U-D Swing [DPT\_1.002 - 1bit] - 0-Off;1-Swing
- 26: Control\_Vanes U-D Move Pos [DPT\_1.017 - 1bit] - 0,1-Move Position

- If set to **"Position"** all the parameters and communication objects for the 4 Vanes positions and Swing will be shown.

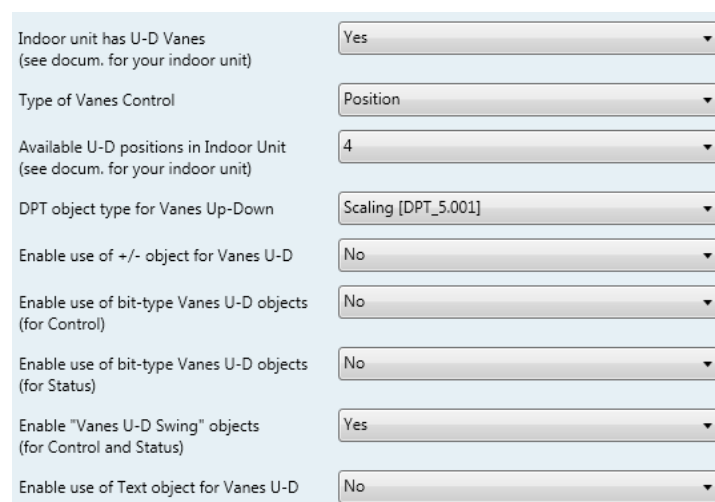

Indoor unit has U-D Vanes (see docum. for your indoor unit)	<input type="text" value="Yes"/>
Type of Vanes Control	<input type="text" value="Position"/>
Available U-D positions in Indoor Unit (see docum. for your indoor unit)	<input type="text" value="4"/>
DPT object type for Vanes Up-Down	<input type="text" value="Scaling [DPT_5.001]"/>
Enable use of +/- object for Vanes U-D	<input type="text" value="No"/>
Enable use of bit-type Vanes U-D objects (for Control)	<input type="text" value="No"/>
Enable use of bit-type Vanes U-D objects (for Status)	<input type="text" value="No"/>
Enable "Vanes U-D Swing" objects (for Control and Status)	<input type="text" value="Yes"/>
Enable use of Text object for Vanes U-D	<input type="text" value="No"/>

**Figure 4.22** Parameter detail

## 4.5.3 Available U-D positions in Indoor Unit

This parameter lets you choose between **"0 (Only Swing)"** and **"4"**.

- If set to **"0 (Only Swing)"** all the parameters and communication objects (if enabled in the parameters dialog) for the swing positions will be shown.

- 24 Control\_Vanes U-D Swing [DPT\_1.002 - 1bit] - 0-Off;1-Swing
- 86 Status\_Vanes U-D Swing [DPT\_1.002 - 1bit] - 0-Off;1-Swing

Type of Vanes Control	Position
Available U-D positions in Indoor Unit (see docum. for your indoor unit)	0 (only Swing)
Enable "Vanes U-D Swing" objects (for Control and Status)	Yes
Enable use of Text object for Vanes U-D	Yes
ASCII strings shown in comm object "Status_Vanes U-D Text"	<< 14-byte string values >>
> String when vanes U-D in POS 1 (if available)	U-D POS 1
> String when vanes U-D in POS 2 (if available)	U-D POS 2
> String when vanes U-D in POS 3 (if available)	U-D POS 3
> String when vanes U-D in POS 4 (if available)	U-D POS 4
> String when vanes U-D in SWING	U-D SWING

**Figure 4.23** Communication Object and parameter details

- If set to "4" all the parameters and communication objects (if enabled in the parameters dialog) for the 4 Vanes positions will be shown.

**Important:** Read the documentation of your indoor unit to check if Up-Down Vanes positions are available.

#### 4.5.4 DPT object type for Vanes Up-Down

With this parameter is possible to change de DPT for the *Control\_Vanes U-D* and *Status\_Vanes U-D* byte-type communication objects. Datapoints Scaling (DPT\_5.001) and Enumerated (DPT\_5.010) can be selected.

**⚠ Important:** The communication objects shown in this section may be different depending on the number of vanes position available, although they all share the same communication object number.

- When "Enumerated [DPT 5.010]" is selected, *Control\_Vanes U-D* and *Status\_Vanes U-D* communication objects for this DPT will appear.

- 19 Control\_Vanes U-D / 4 Pos [DPT\_5.010 - 1byte] - Position values: 1,2,3,4
- 81 Status\_Vanes U-D / 4 Pos [DPT\_5.010 - 1byte] - Position values: 1,2,3,4

To choose a vanes position, values from "1" to "4" can be sent to the *Control\_* object. Each value will correspond to the position (i.e. Value "3" = Position 3).

The *Status\_* object will always return the value for the vane position selected.

⚠ **Important:** If a "0" value is sent to the *Control\_* object, the Position 1 will be selected. If a value bigger than "4" is sent to the *Control\_* object, then the higher Position will be selected.

- When "Scaling [DPT 5.001]" is selected, *Control\_ Vane Up-Down* and *Status\_ Vane Up-Down* communication objects for this DPT will appear.

- 19 *Control\_ Vanes U-D / 4 Pos [DPT\_5.001 - 1byte]* - Thresholds: 38, 63 and 88%
- 81 *Status\_ Vanes U-D / 4 Pos [DPT\_5.001 - 1byte]* - 25, 50, 75 and 100%

The next table shows the range of values that can be sent through the *Control\_* object and the value returned by the *Status\_* object.

	<i>Vanes Pos.1</i>	<i>Vanes Pos.2</i>	<i>Vanes Pos.3</i>	<i>Vanes Pos.4</i>
<i>Control_</i>	0% - 37%	38% - 62%	63% - 87%	88% - 100%
<i>Status_</i>	25%	50%	75%	100%

#### 4.5.5 Enable use of +/- object for Vanes U-D

This parameter shows/hides the *Control\_ Vane Up-Down +/-* communication object which lets change the indoor unit vane position by using two different datapoint types.

- 25 *Control\_ Vanes U-D +/- [DPT\_1.007 - 1bit]* - 0-Decrease;1-Increase

- If set to "No" the object will not be shown.
- If set to "Yes" the *Control\_ Vanes U-D +/-* object and a new parameter will appear.

Enable use of +/- object for Vanes U-D	Yes
> DPT type for +/- Vanes U-D object	0-Decrease / 1-Increase [DPT_1.007]
> Does +/- sequence include SWING vanes Up-Down?	Yes
> Rollover Vanes at upper/lower limit (when controlling with +/- obj)	Yes

Figure 4.24 Parameter detail

#### ➤ DPT type for +/- Vane Up-Down obj

This parameter lets choose between the datapoints **0-Up / 1-Down [DPT\_1.008]** and **0-Decrease / 1-Increase [DPT\_1.007]** for the *Control\_ Vanes U-D +/-* object.

➤ Does +/- sequence include SWING vanes Up-Down?

This parameter lets choose if SWING function is included ("**Yes**") or not ("**No**") in the sequence when using *Control\_ Vanes U-D +/-* object as shown in the discontinuous segment at the picture below.

➤ Roll over Vanes at upper/lower limit

This parameter lets choose if roll-over will be enabled ("**Yes**") or disabled ("**No**") for the *Control\_ Vanes U-D +/-* object.

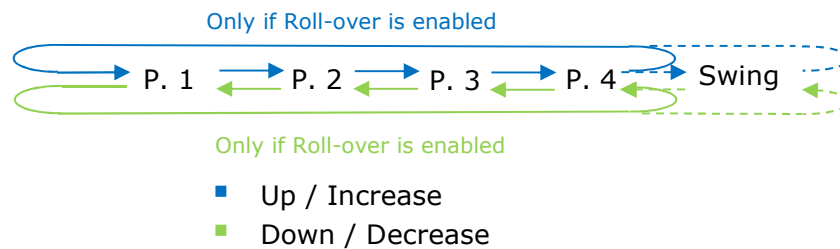

#### 4.5.6 Enable use of bit-type Vane U-D objects (for Control)

This parameter shows/hides the bit-type *Control\_ Vanes U-D* objects.

- ↕ 20 *Control\_ Vanes U-D Pos 1* [DPT\_1.002 - 1bit] - 1-Set Position 1
- ↕ 21 *Control\_ Vanes U-D Pos 2* [DPT\_1.002 - 1bit] - 1-Set Position 2
- ↕ 22 *Control\_ Vanes U-D Pos 3* [DPT\_1.002 - 1bit] - 1-Set Position 3
- ↕ 23 *Control\_ Vanes U-D Pos 4* [DPT\_1.002 - 1bit] - 1-Set Position 4

- If set to "**No**" the objects will not be shown.
- If set to "**Yes**" the *Control\_ Vanes U-D* objects for each Position will appear. To activate a Vanes Position by using these objects, a "**1**" value has to be sent.

#### 4.5.7 Enable use of bit-type Vane U-D objects (for Status)

This parameter shows/hides the bit-type *Status\_ Vanes U-D* objects.

- ↕ 82 *Status\_ Vanes U-D Pos 1* [DPT\_1.002 - 1bit] - 1-Vanes in Position 1
- ↕ 83 *Status\_ Vanes U-D Pos 2* [DPT\_1.002 - 1bit] - 1-Vanes in Position 2
- ↕ 84 *Status\_ Vanes U-D Pos 3* [DPT\_1.002 - 1bit] - 1-Vanes in Position 3
- ↕ 85 *Status\_ Vanes U-D Pos 4* [DPT\_1.002 - 1bit] - 1-Vanes in Position 4

- If set to "**No**" the objects will not be shown.
- If set to "**Yes**" the *Status\_ Vanes U-D* objects for each Position will appear. When a Vanes Position is enabled, a "**1**" value is returned through its bit-type object.

### 4.5.8 Enable "Vanes U-D Swing" objects (for control and status)

This parameter will only be shown if the value "Position" is selected on the 4.5.2 section. It will show/hide *Control\_ Vanes U-D SWING* y *Status\_ Vanes U-D SWING* communication objects.

- 24 Control\_ Vanes U-D Swing [DPT\_1.002 - 1bit] - 0-Off;1-Swing
- 86 Status\_ Vanes U-D Swing [DPT\_1.002 - 1bit] - 0-Off;1-Swing

- If set to **"No"** the object will not be shown.
- If set to **"Yes"** the *Control\_ Vanes U-D Swing* y *Status\_ Vanes U-D Swing* objects will appear.
  - When a **"1"** value is sent to the *Control\_* communication object, Vanes Up-Down will be in Auto mode and the *Status\_* object will return this value.
  - When a **"0"** value is sent to the *Control\_* communication object, Vanes Up-Down will be in Manual mode and the *Status\_* object will return this value.
- ⚠ **Important:** When activating Auto Mode in the indoor unit, this one will choose the best position available for the Vanes Up-Down. This position will not be shown either in the KNX bus or in the remote controller.
- ⚠ **Important:** Read the documentation of your indoor unit to check how many vanes modes are available.

### 4.5.9 Enable use of Text object for Vane U-D

This parameter shows/hides the *Status\_ Vanes U-D Text* communication object.

- 87 Status\_ Vanes U-D Text [DPT\_16.001 - 14byte] - ASCII String

- If set to **"No"** the object will not be shown.
- If set to **"Yes"** the *Status\_ Vanes U-D Text* object will appear. Also, in the parameters will be shown seven text fields, five for the Vane Position and one for the Swing function, that will let modify the text string displayed by the *Status\_ Vanes U-D Text* when changing a vane position.

> String when vanes U-D in POS 1 (if available)	U-D POS 1
> String when vanes U-D in POS 2 (if available)	U-D POS 2
> String when vanes U-D in POS 3 (if available)	U-D POS 3
> String when vanes U-D in POS 4 (if available)	U-D POS 4
> String when vanes U-D in SWING	U-D SWING

Figure 4.25 Parameter detail

## 4.6 Vanes Left-Right Configuration dialog

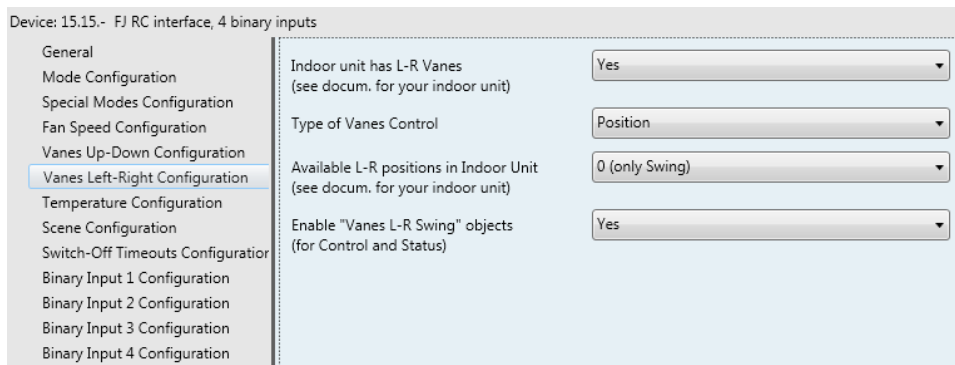
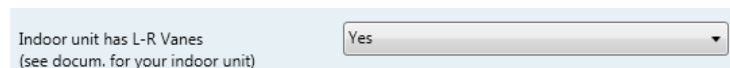

**Figure 4.26** Vanes Left-Right Configuration dialog

All the parameters in this section are related with the Vanes Left-Right properties and communication objects.

### 4.6.1 Indoor unit has L-R Vanes

This parameter lets choose if the unit has Left-Right Vanes available or not.



**Figure 4.27** Parameter detail

- If set to **"No"** all the parameters and communication objects for the Left-Right Vanes will not be shown.
- If set to **"Yes"** all the parameters and communication objects (if enabled in the parameters dialog) for the Left-Right Vanes will be shown.

**⚠ Important:** Read the documentation of your indoor unit to check if Left-Right Vanes are available.

### 4.6.2 Type of Vanes Control

This parameter lets choose if the unit uses a step control no the vanes position or directly a position indication.



**Figure 4.28** Parameter detail

- If set to **"Step"** only the communication objects only for SWING and STEP will be shown.

- ↔ 33 Control\_Vanes L-R Swing [DPT\_1.002 - 1bit] - 0-Off;1-Swing
- ↔ 35 Control\_Vanes L-R Move Pos [DPT\_1.017 - 1bit] - 0,1-Move Position

- If set to **"Position"** all the parameters and communication objects for the 4 Vanes positions and Swing will be shown.

Indoor unit has L-R Vanes (see docum. for your indoor unit)	Yes
Type of Vanes Control	Position
Available L-R positions in Indoor Unit (see docum. for your indoor unit)	5
DPT object type for Vanes Left-Right	Scaling [DPT_5.001]
Enable use of +/- object for Vanes L-R	No
Enable use of bit-type Vanes L-R objects (for Control)	No
Enable use of bit-type Vanes L-R objects (for Status)	No
Enable "Vanes L-R Swing" objects (for Control and Status)	No
Enable use of Text object for Vanes L-R	No

**Figure 4.29** Parameter detail

### 4.6.3 Available L-R positions in Indoor Unit

This parameter lets you choose between **"0 (Only Swing)"** and **"5"**.

- If set to **"0 (Only Swing)"** all the parameters and communication objects (if enabled in the parameters dialog) for the swing positions will be shown.

Indoor unit has L-R Vanes (see docum. for your indoor unit)	Yes
Type of Vanes Control	Position
Available L-R positions in Indoor Unit (see docum. for your indoor unit)	0 (only Swing)
Enable "Vanes L-R Swing" objects (for Control and Status)	No

**Figure 4.30** Parameter and objects detail

- If set to **"5"** all the parameters and communication objects (if enabled in the parameters dialog) for the 5 Vanes positions will be shown.

Indoor unit has L-R Vanes (see docum. for your indoor unit)	Yes
Type of Vanes Control	Position
Available L-R positions in Indoor Unit (see docum. for your indoor unit)	5
DPT object type for Vanes Left-Right	Scaling [DPT_5.001]
Enable use of +/- object for Vanes L-R	No
Enable use of bit-type Vanes L-R objects (for Control)	No
Enable use of bit-type Vanes L-R objects (for Status)	No
Enable "Vanes L-R Swing" objects (for Control and Status)	No
Enable use of Text object for Vanes L-R	No

**Figure 4.31** Parameter and objects detail

**Important:** Read the documentation of your indoor unit to check if Left-Right Vanes positions are available.

#### 4.6.4 DPT object type for Vanes Left-Right

With this parameter is possible to change de DPT for the *Control\_ Vanes L-R* and *Status\_ Vanes L-R* byte-type communication objects. Datapoints Scaling (DPT\_5.001) and Enumerated (DPT\_5.010) can be selected.

**⚠ Important:** The communication objects shown in this section may be different depending on the number of vanes position available, although they all share the same communication object number.

- When **"Enumerated [DPT 5.010]"** is selected, *Control\_ Vanes L-R* and *Status\_ Vanes L-R* communication objects for this DPT will appear.

➡ 27: *Control\_ Vanes L-R / 5 Pos [DPT\_5.010 - 1byte]* - Position values: 1,2,3,4,5

➡ 88: *Status\_ Vanes L-R / 5 Pos [DPT\_5.010 - 1byte]* - Position values: 1,2,3,4,5

To choose a vanes position, values from **"1"** to **"5"** can be sent to the *Control\_* object. Each value will correspond to the position (i.e. Value **"3"** = Position 3).

The *Status\_* object will always return the value for the vane position selected.

**⚠ Important:** If a **"0"** value is sent to the *Control\_* object, the Position 1 will be selected. If a value bigger than **"5"** is sent to the *Control\_* object, then the higher Position will be selected.

- When **"Scaling [DPT 5.001]"** is selected, *Control\_ Vane L-R* and *Status\_ Vane L-R* communication objects for this DPT will appear.

- 27 Control\_Vanes L-R / 5 Pos [DPT\_5.001 - 1byte] - Thresholds: 30, 50, 70 and 90%
- 88 Status\_Vanes L-R / 5 Pos [DPT\_5.001 - 1byte] - 20, 40, 60, 80 and 100%

The next table shows the range of values that can be sent through the *Control\_* object and the value returned by the *Status\_* object.

	Vanes Pos.1	Vanes Pos.2	Vanes Pos.3	Vanes Pos.4	Vanes Pos.5
<i>Control_</i>	0% - 29%	30% - 49%	50% - 69%	70% - 89%	90% - 100%
<i>Status_</i>	20%	40%	60%	80%	100%

#### 4.6.5 Enable use of +/- object for Vanes L-R

This parameter shows/hides the *Control\_ Vane L-R +/-* communication object which lets change the indoor unit vane position by using two different datapoint types. It is only present when "5" is selected on the "Available L-R position Indoor Unit" dropdown menu.

- 34 : Control\_Vanes L-R +/- [DPT\_1.007 - 1bit] - 0-Decrease;1-Increase

- If set to "No" the object will not be shown.
- If set to "Yes" the *Control\_ Vanes L-R +/-* object and a new parameter will appear.

Figure 4.32 Parameter detail

##### ➤ DPT type for +/- Vane L-R obj

This parameter lets choose between the datapoints **0-Up / 1-Down [DPT\_1.008]** and **0-Decrease / 1-Increase [DPT\_1.007]** for the *Control\_ Vanes L-R +/-* object.

##### ➤ Does +/- sequence include SWING vanes Left-Right?

This parameter lets choose if SWING function is included ("Yes") or not ("No") in the sequence when using *Control\_ Vanes L-R +/-* object as shown in the discontinuous segment at the picture below.

##### ➤ Roll over Vanes at upper/lower limit

This parameter lets choose if roll-over will be enabled (“**Yes**”) or disabled (“**No**”) for the *Control\_ Vanes L-R +/-* object.

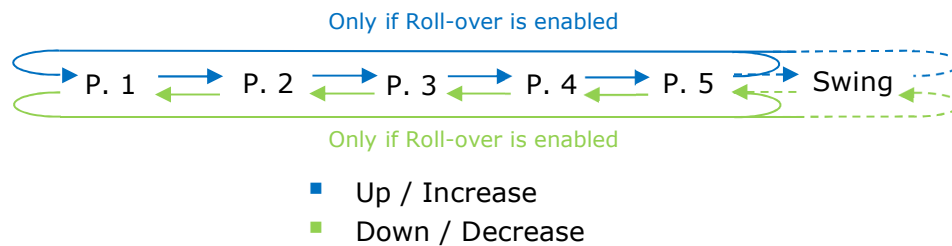

#### 4.6.6 Enable use of bit-type Vane L-R objects (for Control)

This parameter shows/hides the bit-type *Control\_ Vanes L-R* objects.

- ↕ 28 Control\_ Vanes L-R Pos 1 [DPT\_1.002 - 1bit] - 1-Set Position 1
- ↕ 29 Control\_ Vanes L-R Pos 2 [DPT\_1.002 - 1bit] - 1-Set Position 2
- ↕ 30 Control\_ Vanes L-R Pos 3 [DPT\_1.002 - 1bit] - 1-Set Position 3
- ↕ 31 Control\_ Vanes L-R Pos 4 [DPT\_1.002 - 1bit] - 1-Set Position 4
- ↕ 32 Control\_ Vanes L-R Pos 5 [DPT\_1.002 - 1bit] - 1-Set Position 5

- If set to “**No**” the objects will not be shown.
- If set to “**Yes**” the *Control\_ Vanes L-R* objects for each Position will appear. To activate a Vanes Position by using these objects, a “**1**” value has to be sent.

#### 4.6.7 Enable use of bit-type Vane L-R objects (for Status)

This parameter shows/hides the bit-type *Status\_ Vanes L-R* objects.

- ↕ 89 Status\_ Vanes L-R Pos 1 [DPT\_1.002 - 1bit] - 1-Vanes in Position 1
- ↕ 90 Status\_ Vanes L-R Pos 2 [DPT\_1.002 - 1bit] - 1-Vanes in Position 2
- ↕ 91 Status\_ Vanes L-R Pos 3 [DPT\_1.002 - 1bit] - 1-Vanes in Position 3
- ↕ 92 Status\_ Vanes L-R Pos 4 [DPT\_1.002 - 1bit] - 1-Vanes in Position 4
- ↕ 93 Status\_ Vanes L-R Pos 5 [DPT\_1.002 - 1bit] - 1-Vanes in Position 5

- If set to “**No**” the objects will not be shown.
- If set to “**Yes**” the *Status\_ Vanes L-R* objects for each Position will appear. When a Vanes Position is enabled, a “**1**” value is returned through its bit-type object.

#### 4.6.8 Enable “Vanes L-R Swing” objects (for control and status)

This parameter will only be present if parameter on 4.6.2 is set to **"Position"**. It will show/hide *Control\_ Vanes L-R SWING* y *Status\_ Vanes L-R SWING* communication objects.

- ↕ 33 Control\_ Vanes L-R Swing [DPT\_1.002 - 1bit] - 0-Off;1-Swing
- ↕ 94 Status\_ Vanes L-R Swing [DPT\_1.002 - 1bit] - 0-Off;1-Swing

- If set to **"No"** the object will not be shown.
- If set to **"Yes"** the *Control\_ Vanes L-R Swing* y *Status\_ Vanes L-R Swing* objects will appear.
  - When a **"1"** value is sent to the *Control\_* communication object, Vanes Left-Right will be in Auto mode and the *Status\_* object will return this value.
  - When a **"0"** value is sent to the *Control\_* communication object, Vanes Left-Right will be in Manual mode and the *Status\_* object will return this value.
- ⚠ **Important:** When activating Auto Mode in the indoor unit, this one will choose the best position available for the Vanes Left-Right. This position will not be shown either in the KNX bus or in the remote controller.
- ⚠ **Important:** Read the documentation of your indoor unit to check how many vanes modes are available.

#### 4.6.9 Enable use of Text object for Vane L-R

This parameter shows/hides the *Status\_ Vanes L-R Text* communication object.

- ↕ 95 Status\_ Vanes L-R Text [DPT\_16.001 - 14byte] - ASCII String

- If set to **"No"** the object will not be shown.
- If set to **"Yes"** the *Status\_ Vanes L-R Text* object will appear. Also, in the parameters will be shown seven text fields, five for the Vane Position and one for the Swing function, that will let modify the text string displayed by the *Status\_ Vanes L-R Text* when changing a vane position.

ASCII strings shown in comm object "Status_ Vanes L-R Text"	<< 14-byte string values >>
> String when vanes L-R in POS 1 (if available)	L-R POS 1
> String when vanes L-R in POS 2 (if available)	L-R POS 2
> String when vanes L-R in POS 3 (if available)	L-R POS 3
> String when vanes L-R in POS 4 (if available)	L-R POS 4
> String when vanes L-R in POS 5 (if available)	L-R POS 5
> String when vanes L-R in SWING	L-R SWING

**Figure 4.33** Parameter detail

## 4.7 Temperature Configuration dialog

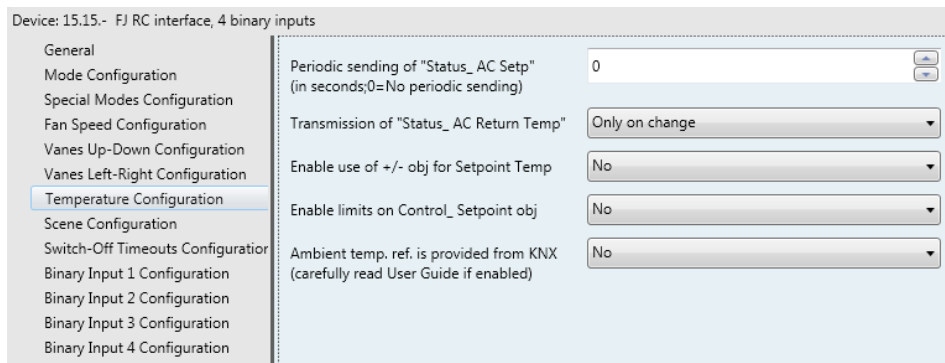

Figure 4.34 Default Temperature Configuration dialog

All the parameters in this section are related with the Temperature properties and communication objects.

### 4.7.1 Periodic sending of "Status\_ AC Setp"

This parameter lets change the interval of time (in seconds, from 0 to 255) at the end of which the AC setpoint temperature is sent to the KNX bus. For a "0" value, the AC setpoint temperature will ONLY be sent on change. The AC setpoint temperature is sent through the communication object *Status\_ AC Setpoint Temp*.

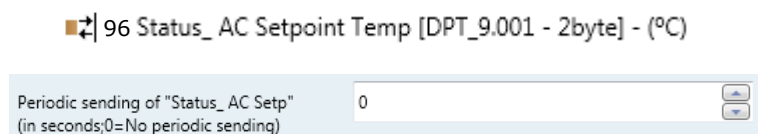

Figure 4.35 Communication object and parameter detail

**⚠ Important:** In case the ambient temperature is provided from KNX, the setpoint temperature returned from this object, will be the one resulting from the formula shown in the section "4.6.4 Ambient temp. ref. is provided from KNX".

### 4.7.2 Transmission of "Status\_ AC Ambient Ref Temp"

This parameter lets to you choose if the AC return temperature will be sent **"only cyclically"**, **"only on change"** or **"cyclically and on change"**. The AC return temperature is sent through the communication object *Status\_ AC Ambient Ref Temp*.

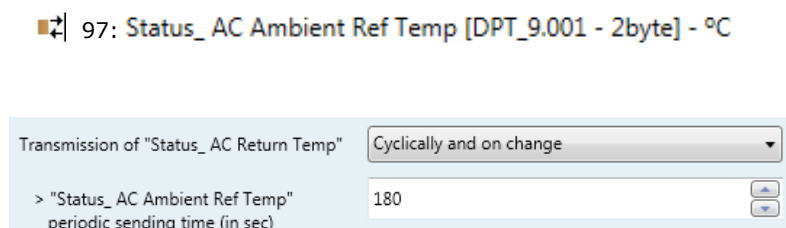

Figure 4.36 Parameter detail

- "Status AC Ambient Ref Temp" periodic sending time (in sec)

This parameter will only be available for the **"only cyclically"** and **"cyclically and on change"** options, and lets you change the interval of time (in seconds, from 1 to 255) at the end of which the AC return temperature is sent to the KNX bus.

#### 4.7.3 Enable use of +/- object for Setpoint Temp

This parameter shows/hides the *Control\_Setpoint Temp +/-* communication object which lets change the indoor unit setpoint temperature by using two different datapoint types.

■ ↕ 37 Control\_Setpoint Temp +/- [DPT\_1.007 - 1bit] - 0-Decrease;1-Increase





- If set to **"No"** the object will not be shown.
- If set to **"Yes"** the *Control\_Setpoint Temp +/-* object and a new parameter will appear.

Enable use of +/- obj for Setp Temp	yes
> DPT type for +/- Setp Temp object	0-Up / 1-Down [DPT_1.008]

**Figure 4.37** Parameter detail

- DPT type for +/- Setp Temp object

This parameter lets choose between the datapoints **0-Up / 1-Down [DPT\_1.008]** and **0-Decrease / 1-Increase [DPT\_1.007]** for the *Control\_Setpoint Temp +/-* object.

(Lower limit) **18°C**  19°C  ...  29°C  **30°C** (Upper limit)

- Up / Increase
- Down / Decrease

#### 4.7.4 Enable limits on Control\_Setpoint obj

This parameter enables to define temperature limits for the *Control\_Setpoint Temperature* object.

Enable limits on Control_Setpoint obj	Yes
> Lower limit (°C)	18 °C
> Upper limit (°C)	30 °C

**Figure 4.38** Parameter detail

- If set to **"No"** the setpoint temperature limits for the *Control\_Setpoint Temperature* object will be the default: 16°C for the lower limit and 31°C for the upper limit.

- If set to **"Yes"** it is possible to define temperature limits for the *Control\_ Setpoint Temperature* object.

- Control\_ Set Temp Lower limit (°C)

This parameter lets to define the lower limit for the setpoint temperature.

- Control\_ Set Temp Upper limit (°C)

This parameter lets to define the upper limit for the setpoint temperature.

⚠ **Important:** *If a setpoint temperature above the upper defined limit (or below the lower defined limit) is sent through the Control\_ Setpoint Temperature object, it will be ALWAYS applied the limit defined.*

⚠ **Important:** *When limits are enabled, any setpoint temperature sent to the AC (even through scenes, special modes, etc.) will be limited.*

#### 4.7.5 Ambient temp. ref. is provided from KNX

This parameter shows/hides the *Control\_ Ambient Temperature* communication object which lets use an ambient temperature reference provided by a KNX device.

🔗 38 Control\_ Ambient Temp [DPT\_9.001 - 2byte] - °C

- If set to **"No"** the object will not be shown and the ambient temperature will never be send to the AC unit.
- If set to **"Yes"** the *Control\_ Ambient Temp* object will appear. Meant to be enabled when you want the temperature provided by a KNX sensor to be the reference ambient temperature for the air conditioner.

#### 4.8 Scene Configuration dialog

Configuration Option	Value
Enable use of scenes	Yes
Scenes can be stored from KNX bus	No
Enable use of bit objects for scene execution	No
Scene 1 preset	No
Scene 2 preset	No
Scene 3 preset	No
Scene 4 preset	No
Scene 5 preset	No

**Figure 4.39** Parameter detail

All the parameters in this section are related with the Scene properties and communication objects. A scene contains values of: On/Off, Mode, Fan speed, Vane position, Setpoint Temperature and Remote Controller Disablement.

### 4.8.1 Enable use of scenes

This parameter shows/hides the scene configuration parameters and communication objects.

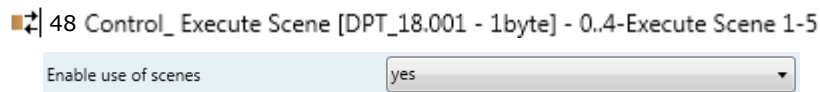

Figure 4.40 Parameter detail

- If set to **"No"** the scene parameters and communication objects will not be shown.
- If set to **"Yes"** the scene parameters and communication objects will be shown. To execute a scene through the byte-type object, a value from **"0"** to **"4"** has to be sent, corresponding each one to a different scene (i.e. "0" = Scene 1;... "4" = Scene 5).

### 4.8.2 Scenes can be stored from KNX bus

This parameter shows/hides the *Control\_ Save/Exec Scene* and all the *Control\_ Store Scene* (if enabled) communication objects.



- If set to **"No"** the communication objects will not be shown.
- If set to **"Yes"** the communication objects and a new parameter will appear. To store a scene through the byte-type object, a value from **"128"** to **"132"** has to be sent to the object, corresponding each one to a different scene (i.e. "128" = Scene 1;... "132" = Scene 5).

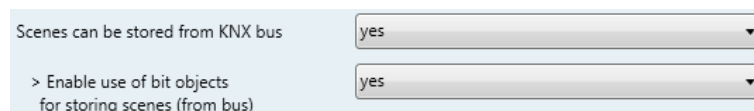
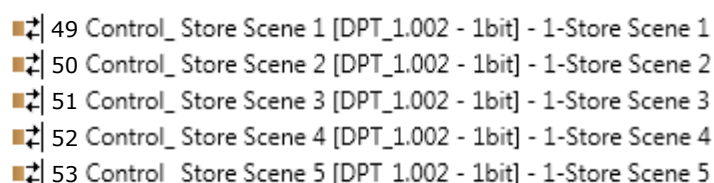

Figure 4.41 Parameter detail

#### ➤ Enable use of bit objects for storing scenes (from bus)

If set to **"No"** the objects will not be shown.

If set to **"Yes"** the *Control\_ Store Scene* objects for storing scenes will appear. To store a scene by using these objects, a **"1"** value has to be sent to the scene's object we want to store (i.e. to store scene 4, a "1" has to be sent to the *Control\_ Store Scene 4* object).



### 4.8.3 Enable use of bit objects for scene execution

This parameter shows/hides the *Control\_ Execute Scene* bit-type communication objects.

Figure 4.42 Parameter detail

- If set to **"No"** the communication objects will not be shown.
- If set to **"Yes"** the communication objects will appear. To execute a scene by using these objects, a **"1"** value has to be sent to the scene's object we want to execute (i.e. to execute scene 4, a "1" has to be sent to the *Control\_ Execute Scene 4* object).

- ↕ 54 Control\_ Execute Scene 1 [DPT\_1.002 - 1bit] - 1-Execute Scene 1
- ↕ 55 Control\_ Execute Scene 2 [DPT\_1.002 - 1bit] - 1-Execute Scene 2
- ↕ 56 Control\_ Execute Scene 3 [DPT\_1.002 - 1bit] - 1-Execute Scene 3
- ↕ 57 Control\_ Execute Scene 4 [DPT\_1.002 - 1bit] - 1-Execute Scene 4
- ↕ 58 Control\_ Execute Scene 5 [DPT\_1.002 - 1bit] - 1-Execute Scene 5

### 4.8.4 Scene "x" preset

This parameter lets define a preset for a scene (the following description is valid for all the scenes).

Figure 4.43 Parameter detail

- If set to **"No"** the preset for the scene "x" will be disabled.
- If set to **"Yes"** the preset will be enabled. When a scene is executed the values configured in the preset will be applied.

**⚠ Important:** If a scene's preset is enabled, will not be possible to modify (store) the scene from the KNX bus.

Figure 4.44 Parameter detail

#### ➤ Scene "x" / Value for On-Off

This parameter lets choose the power of the indoor unit when the scene is executed. The following options are available: **"ON"**, **"OFF"** or **"(unchanged)"**.

➤ Scene "x" / Value for Mode

This parameter lets choose the mode of the indoor unit when the scene is executed. The following options are available: **"AUTO"**, **"HEAT"**, **"COOL"**, **"FAN"**, **"DRY"**, or **"(unchanged)"**.

➤ Scene "x" / Value for Fan Speed

This parameter lets choose the fan speed of the indoor unit when the scene is executed. The following options are available: **"FAN SPEED AUTO"**, **"FAN SPEED 1"**, **"FAN SPEED 2"**, **"FAN SPEED 3"**, **"FAN SPEED 4 (if available)"** or **"(unchanged)"**.

➤ Scene "x" / Value for Vane U-D (if available)

This parameter lets choose the vane position of the indoor unit when the scene is executed. The following options are available: **"VANES U-D OFF"**, **"VANES U-D POS 1(if available)"**, **"VANES U-D POS 2(if available)"**, **"VANES U-D POS 3(if available)"**, **"VANES U-D POS 4(if available)"**, **"VANES U-D SWING"** or **"(unchanged)"**.

➤ Scene "x" / Value for Vane L-R (if available)

This parameter lets choose the vane position of the indoor unit when the scene is executed. The following options are available: **"VANES L-R OFF"**, **"VANES L-R POS 1(if available)"**, **"VANES L-R POS 2(if available)"**, **"VANES L-R POS 3(if available)"**, **"VANES L-R POS 4(if available)"**, **"VANES L-R POS 5(if available)"**, **"VANES L-R SWING"** or **"(unchanged)"**.

➤ Scene "x" / Value for Setpoint Temp (°C)

This parameter lets choose the setpoint temperature of the indoor unit when the scene is executed. The following options are available: from **"18°C"** to **"30°C"** (both included) or **"(unchanged)"**.

➤ Scene "x" / Value for Remote Lock

This parameter lets choose the remote controller status of the indoor unit when the scene is executed. The following options are available: **"Locked (remote not allowed)"**, **"unlocked (remote allowed)"** or **"(unchanged)"**.

⚠ **Important:** If any preset value is configured as **"(unchanged)"**, the execution of this scene will not change current status of this feature in the AC unit.

⚠ **Important:** When a scene is executed, *Status\_ Current Scene* object shows the number of this scene. Any change in previous items does *Status\_ Current Scene* show **"No Scene"**. Only changes on items marked as **"(unchanged)"** will not disable current scene.

## 4.9 Switch-Off Timeouts Configuration dialog

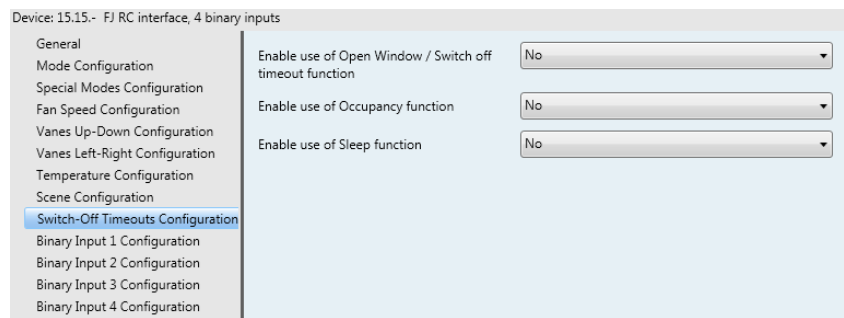

**Figure 4.45** Default Switch-Off Timeouts Configuration dialog

All the parameters in this section are related with the timeout properties and communication objects.

### 4.9.1 Enable use of Open Window / Switch off timeout function

This parameter shows/hides the *Control\_ Switch Off Timeout* communication object which lets Start/Stop a timeout to switch off the indoor unit.

- 39 Control\_ Switch Off Timeout [DPT\_1.010 - 1bit] - 0-Stop;1-Start
- 39 Control\_ Window Contact Status [DPT\_1.009 - 1bit] - 0-Open;1-Closed

- If set to **"No"** the object will not be shown.
- If set to **"Yes"** the *Control\_ Switch Off Timeout* object and new parameters will appear. If a **"1"** value is sent to this object, and the indoor unit is already turned on, the switch-off timeout will begin. If a **"0"** value is sent to this object, the switch-off timeout will stop.

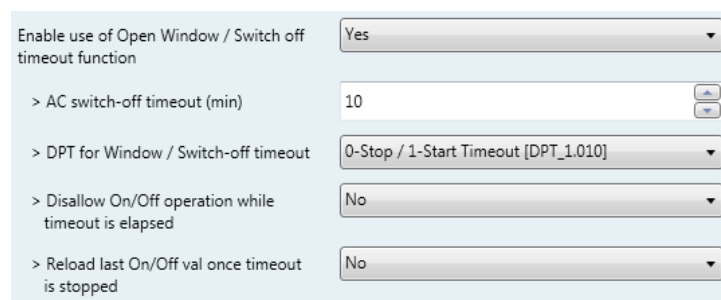

**Figure 4.46** Parameter detail

#### ➤ AC switch-off timeout (min)

This parameter lets select how much time (in minutes) to wait before switching off the indoor unit.

#### ➤ DPT for Window / Switch-off timeout

This parameter lets choose between the datapoints **0-Open / 1-Closed Window [DPT\_1.009]** and **0-Stop / 1-Start Timeout [DPT\_1.010]** for the *Control\_Switch Off Timeout*.

➤ Disallow On/Off operation while window is Open

If set to **"No"**, On/Off commands while the window is open will be accepted.

- If a **"1"** value is sent to the *Control\_Switch Off Timeout* object the switch-off timeout period will begin again.
- If a **"0"** value is sent to the *Control\_Switch Off Timeout* object, No action will be performed.

If set to **"Yes"**, On/Off commands, while the window is open, will be saved (but not applied). These commands will be used in the next parameter if set to **"Yes"**.

➤ Reload last On/Off val once window is closed?

If set to **"No"**, once the switch-off timeout is stopped, any value will be reloaded.

If set to **"Yes"**, once the switch-off timeout is stopped, the last On/Off value sent will be reloaded.

- If a **"1"** value is sent to the *Control\_Switch Off Timeout* object after the timeout period, the indoor unit will **turn on**.
- If a **"0"** value is sent to the *Control\_Switch Off Timeout* after the timeout period, No action will be performed.

## 4.9.2 Enable use of Occupancy function

This parameter shows/hides the *Control\_Occupancy* communication object which lets apply different parameters to the indoor unit depending on the presence/No presence in the room.

➤ 40 Control\_Occupancy [DPT\_1.018 - 1bit] - 0-Not Occupied;1-Occupied

- If set to **"No"** the object will not be shown.
- If set to **"Yes"** the *Control\_Occupancy* object and new parameters will appear. If a **"1"** value is sent to this object (No room occupancy), the timeout will begin. If a **"0"** value is sent to this object, the timeout will stop.

Enable use of Occupancy function	Yes
> Timeout to apply action (minutes)	20
> Action after timeout elapsed	Switch-Off AC
> Disallow On/Off operation while not Occupied	No
> Reload last On/Off value when Occupied	No

Figure 4.47 Parameter detail

➤ Timeout to apply action (minutes)

This parameter lets choose how much time to wait (in minutes) before executing the action specified in the next parameter ("Action after timeout elapsed").

➤ Action after timeout elapsed

When **Switch-Off** is selected, once the timeout has elapsed, the indoor unit will be turned off.

When **Apply Preset Delta** is selected, once the timeout has elapsed, a delta temperature will be applied in order to save energy (decreasing the setpoint when in Heat mode, or increasing the setpoint when in Cool mode). Also new parameters will appear.

> Temp delta decrease (HEAT) or increase (COOL) (°C)	2.0°C
> Enable secondary timeout	yes

Figure 4.48 Parameter detail

➤ Temp delta decrease (HEAT) or increase (COOL) (°C)

This parameter lets configure the delta temperature (increase or decrease) that will be applied when the timeout has elapsed.

- ⚠ **Important:** When there is occupancy again after the application of a delta, the same delta will be applied inversely. (i.e. In a room with AC in cool mode and 25°C setpoint temperature, a **+2°C** delta is applied after the occupancy timeout, setting the setpoint at 27°C because there is No occupancy in the room. If the setpoint is raised to 29°C during that period, when the room is occupied again, a **-2°C** delta will be applied and the final setpoint temperature will then be 27°C).

➤ Enable secondary timeout

If set to **"No"** nothing will be applied.

If set to **"Yes"**, a new timeout will be enabled and two new parameters will appear.

> Timeout to apply action (min)	2
> Action after timeout elapsed	Apply Preset Delta
> Temp delta dec (HEAT) / or inc (COOL) (°C)	2.0°C

Figure 4.49 Parameter detail

➤ Timeout to apply action (minutes)

This parameter lets choose how much time to wait (in minutes) before executing the action specified in the next parameter ("Action after timeout elapsed").

➤ Action after timeout elapsed

When **Switch-Off** is selected, once the timeout has elapsed, the indoor unit will turn off.

When **Apply Preset Delta** is selected, once the timeout configured is extinguished, a delta temperature will be applied (decreasing the setpoint when in Heat mode, or increasing the setpoint when in Cool mode). Also new parameters will appear.

➤ Temp delta decrease (HEAT) or increase (COOL) (°C)

This parameter lets configure the delta temperature that will be applied when the timeout is extinguished.

**⚠ Important:** *When there is occupancy again after the application of a delta, the same delta will be applied inversely as explained above.*

➤ Disallow On/Off operation while not Occupied

If set to **"No"**, On/Off commands while the window is open will be accepted.

- If a **"1"** value is sent to the *Control\_ Occupancy* object the switch-off timeout period will begin again.
- If a **"0"** value is sent to the *Control\_ Occupancy* object, No action will be performed.

If set to **"Yes"**, On/Off commands while not occupied will be saved (but not applied). These commands will be used in the next parameter if set to **"Yes"**.

> Reload last On/Off value when Occupied	yes
> Disallow On/Off operation while not Occupied	yes

Figure 4.50 Parameter detail

➤ Reload last On/Off value when Occupied

If set to **"No"**, once the switch-off timeout has elapsed, any value will be reloaded.

If set to **"Yes"**, once the switch-off timeout has elapsed, the last On/Off value will be reloaded.

- If a **"1"** value is sent to the *Control\_ Occupancy* object after the timeout period, the indoor unit will **turn on**.
- If a **"0"** value is sent to the *Control\_ Occupancy* after the timeout period No action will be performed.

#### 4.9.3 Enable use of SLEEP timeout

This parameter shows/hides the *Control\_ Sleep Timeout* communication object which lets start a timeout to automatically turn off the indoor unit.

➤ 41 Control\_ Sleep Timeout [DPT\_1.010 - 1bit] - 0-Stop;1-Start

- If set to **"No"** the object will not be shown.
- If set to **"Yes"** the *Control\_ Sleep Timeout* object and a new parameter will appear. If a **"1"** value is sent to this object the switch-off timeout will begin. If a **"0"** value is sent to this object, the switch-off timeout will stop.

Enable use of SLEEP timeout	yes
> Sleep function switch-off timeout (minutes)	1

Figure 4.51 Parameter detail

➤ Timeout to apply action (minutes)

This parameter lets select how much time (in minutes) to wait before switching off the AC unit.

## 4.10 Binary Input “x” Configuration dialog

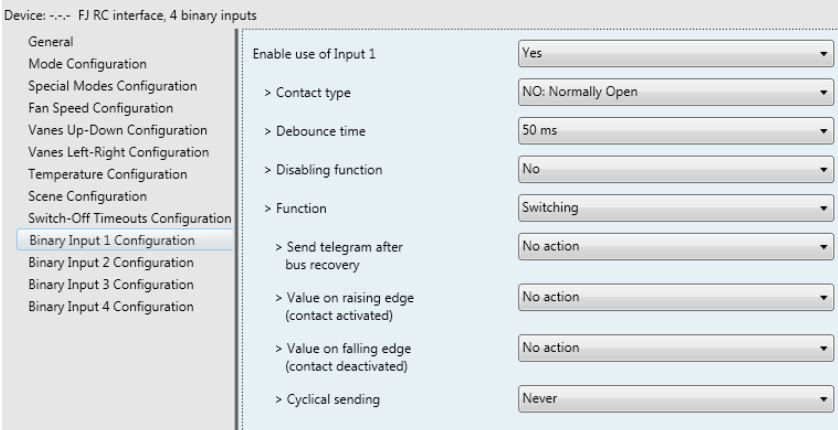

Figure 4.52 Parameter detail

All the parameters in this section are related with the binary inputs properties and communication objects.

### 4.10.1 Enable use of Input “x”

This parameter enables the use of the Input “x” and shows/hides the *Status\_Inx* communication object(s) which will act as configured in the “Function” parameter.

- 109 Status\_In1 - Switching [DPT\_1.001 - 1bit] - 0-Off;1-On
- 110 Status\_In2 - Switching [DPT\_1.001 - 1bit] - 0-Off;1-On
- 111 Status\_In3 - Switching [DPT\_1.001 - 1bit] - 0-Off;1-On
- 112 Status\_In4 - Switching [DPT\_1.001 - 1bit] - 0-Off;1-On

- If set to **“No”** the objects will not be shown.
- If set to **“Yes”** the *Status\_Inx* object(s) and new parameters will appear.

### 4.10.2 Contact type

This parameter lets choose the behavior that will have the binary input depending on if the contact is Normally open or Normally closed.

- There are two possible options to configure the contact type: **“NO: Normally Open”** and **“NC: Normally Closed”**.

### 4.10.3 Debounce time

This parameter lets choose a debounce time (in milliseconds) that will be applied to the contact.

#### 4.10.4 Disabling function

This parameter shows/hides the *Control\_Disable Input x* communication object which will let disable/enable the input x.

- ↕ 59 Control\_Disable Input 1 [DPT\_1.003 - 1bit] - 0-Disable;1-Enable;
- ↕ 59 Control\_Disable Input 1 [DPT\_1.002 - 1bit] - 0-False;1-True

- If set to **"No"** any object will be shown.
- When **"DPT 1.003: 0-Disable; 1-Enable"** is selected, the input can be disabled using the value **"0"** and enabled using the value **"1"**.
- When **"DPT 1.002: 1-True (Disable); 0-False (Enable)"** is selected, the input can be disabled using the value **"1"** and enabled using the value **"0"**.

#### 4.10.5 Function

This parameter lets choose the function that will have the binary input. There are 7 different functions available: Switching, Dimming, Shutter/Blind, Value, Execute Scene (internal), Occupancy (internal) and Window Contact (internal).

- When **"Switching"** is selected the communication object and new parameters for the Input "x" will appear as shown below.

■ ↕ 109 Status\_In1 - Switching [DPT\_1.001 - 1bit] - 0-Off;1-On

> Function	Switching
> Send telegram after bus recovery	No action
> Value on raising edge (contact activated)	Toggle (On/Off)
> Value on falling edge (contact deactivated)	No action
> Cyclical sending	Never

Figure 4.53 Parameter detail

##### ➤ Send telegram after bus recovery

This parameter lets select if the Binary Input "x" will send a telegram, or not, after a bus recovery and the type of telegram sent (if enabled).

- When **"No action"** is selected, No telegram will be sent after a bus recovery.
- When **"Current status"** is selected, the binary input will send a telegram with its current status after a bus recovery. Also a new parameter will appear (see below).
- When **"On"** is selected, the binary input will send a telegram with a **"1"** value after a bus recovery. Also a new parameter will appear (see below).

- When **"Off"** is selected, the binary input will send a telegram with a **"0"** value after a bus recovery. Also a new parameter will appear (see below).



**Figure 4.54** Parameter detail

➤ Sending delay after a bus recovery (seconds)

This parameter lets configure a delay (in seconds) that will be applied after a bus recovery and, after which, a telegram will be sent.

➤ Value on rising edge

This parameter lets select the value that the Binary Input "x" will send on a rising edge (contact activated).

- When **"On"** is selected, the binary input will always send telegrams with a **"1"** value.
- When **"Off"** is selected, the binary input will always send telegrams with a **"0"** value.
- When **"Toggle (On/Off)"** is selected, the binary input will send a **"1"** value after a **"0"** value and viceversa.
- When **"No action"** is selected, the binary input will not perform any action.

➤ Value on falling edge

This parameter lets select the value that the Binary Input "x" will send on a falling edge (contact deactivated).

- When **"On"** is selected, the binary input will always send telegrams with a **"1"** value.
- When **"Off"** is selected, the binary input will always send telegrams with a **"0"** value.
- When **"Toggle (On/Off)"** is selected, the binary input will send a **"1"** value after a **"0"** value and viceversa.
- When **"No action"** is selected, the binary input will not perform any action.

➤ Cyclical sending

This parameter lets enable/disable cyclical sending when a determined condition is met.

- When **"When output value is On"** is selected, everytime a **"1"** value is sent, it will be sent cyclically. Also a new parameter will appear (see below).
  - When **"When output value is Off"** is selected, everytime a **"0"** value is sent, it will be sent cyclically. Also a new parameter will appear (see below).
  - When **"Always"** is selected, the binary input will send any value cyclically. Also a new parameter will appear (see below).
  - When **"Never"** is selected, cyclical sending will be disabled.
- Period for cyclical sending (seconds)

This parameter lets configure a time (in seconds) for the cyclical sending.

**Figure 4.55** Parameter detail

- When **"Dimming"** is selected the communication objects and new parameters for the Input "x" will appear as shown below.

➤ 109 Status\_In1 - Dimming - On/Off [DPT\_1.001 - 1bit] - 0-Off;1-On  
➤ 110 Status\_In1 - Dimming - Step(%) [DPT\_3.007 - 4bit] - Dimming step

> Function	Dimming
> Send telegram after bus recovery	No action
> Mode for short (long) operation	Toggle: On/Off (increase/decrease)
> Increasing step	+ 100 %
> Decreasing step	- 100 %
> Short/long operation limit (x100ms)	10
> Cyclical sending period (x100ms) (0-No cyclical sending)	0

**Figure 4.56** Parameter detail

➤ Send telegram after bus recovery

This parameter lets select if the Binary Input "x" will send a telegram, or not, after a bus recovery and the type of telegram sent (if enabled).

- When **"No action"** is selected, No telegram will be sent after a bus recovery.
- When **"On"** is selected, the binary input will send a telegram with a **"1"** value after a bus recovery. Also a new parameter will appear (see below).
- When **"Off"** is selected, the binary input will send a telegram with a **"0"** value after a bus recovery. Also a new parameter will appear (see below).

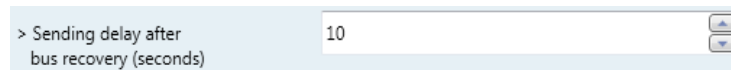

**Figure 4.57** Parameter detail

➤ Sending delay after a bus recovery (seconds)

This parameter lets configure a delay (in seconds) that will be applied after a bus recovery and, after which, a telegram will be sent.

➤ Mode for short (long) operation

This parameter lets select the value that the Binary Input "x" will send on a rising edge (contact activated), for a short and a long operation.

- When **"On (increase)"** is selected, the binary input will always send telegrams with a **"1"** value for a short operation, and an **"increase step"** for a long operation.
- When **"Off (decrease)"** is selected, the binary input will always send telegrams with a **"0"** value for a short operation, and an **"decrease step"** for a long operation.
- When **"Toggle: On/Off (increase/decrease)"** is selected:
  - For the short operation the binary input will send a **"1"** value after a **"0"** value and viceversa.
  - For the long operation the binary input will send an **"increase step"** after a **"decrease step"** and viceversa.

⚠ **Important:** note that the first long operation in toggle depends on the last short operation, meaning that after a **"1"** value will be sent a **"decrease step"** and after a **"0"** value will be sent an **"increase step"**.

⚠ **Important:** The time period between a short and a long operation is defined in the parameter "Short/long operation limit (x100ms)".

➤ Increasing step

This parameter lets select the increasing step value (in %) that will be sent for a long operation.

➤ Decreasing step

This parameter lets select the decreasing step value (in %) that will be sent for a long operation.

➤ Short/long operation limit (x100ms)

This parameter lets introduce the time period difference for the short and the long operation.

➤ Cycl. send. period in long oper. (x100ms)

This parameter lets configure a time (in seconds) for the cyclical sending of a long operation.

- When **"Shutter/Blind"** is selected the communication objects and new parameters for the Input "x" will appear as shown below.

- ↕ 109 Status\_In1 - Shut/Blind - Step [DPT\_1.007 - 1bit] - 0-Step Up;1-Step Down
- ↕ 110 Status\_In1 - Shut/Blind - Move [DPT\_1.008 - 1bit] - 0-Move Up;1-Move Down

The screenshot shows a configuration panel for a 'Shutter/Blind' function. The parameters are as follows:

> Function	Shutter/Blind
> Send telegram after bus recovery	No action
> Operation	Toggle (Up/Down)
> Method	Step-Move-Step
> Short/long operation limit (x100ms)	10
> Vanes adjustment time (x100ms)	10

Figure 4.58 Parameter detail

➤ Send telegram after bus recovery

This parameter lets select if the Binary Input "x" will send a telegram, or not, after a bus recovery and the type of telegram sent (if enabled).

- When **"No action"** is selected, No telegram will be sent after a bus recovery.
- When **"Move Up"** is selected, the binary input will send a telegram with a **"0"** value after a bus recovery. Also a new parameter will appear (see below).
- When **"Move Down"** is selected, the binary input will send a telegram with a **"1"** value after a bus recovery. Also a new parameter will appear (see below).

The screenshot shows a single parameter configuration field:

> Sending delay after bus recovery (seconds)	10
--	----

Figure 4.44 Parameter detail

➤ Sending delay after a bus recovery (seconds)

This parameter lets configure a delay (in seconds) that will be applied after a bus recovery and, after which, a telegram will be sent.

➤ Operation

This parameter lets select the value that the Binary Input "x" will send on a rising edge (contact activated).

- When **"Up"** is selected, the binary input will always send telegrams with a **"0"**.
- When **"Down"** is selected, the binary input will always send telegrams with a **"1"** value.
- When **"Toggle (Up/Down)"** is selected the binary input will send a **"0"** value after a **"1"** value and viceversa.

➤ Method

This parameter lets select the working method for the shutter/blind.

- When **"Step-Move-Step"** is selected: On a rising edge (contact activated) a step/stop telegram will be sent and will begin a time called **T1**. If a falling edge occurs (contact deactivated) during the **T1**, No action will be performed.

If the rising edge is maintained longer than **T1**, a move telegram will be sent and will start a time called **T2**. If a falling edge occurs during the **T2**, a step/stop telegram will be sent. If a falling edge occurs after **T2** No action will be performed.

- When **"Move-Step"** is selected: On a rising edge a move telegram will be sent and will begin the **T2** time. If a falling edge occurs during the **T2**, a step/stop telegram will be sent. If a falling edge occurs after **T2** No action will be performed.

⚠ **Important:** The **T1** time have to be defined in the "Short/long operation limit (x100ms)" parameter. Also the **T2** time have to be defined in the "Vanes adjustment time (x100ms)" parameter.

➤ Short/long operation limit (x100ms)

This parameter lets introduce the time period difference for the short and the long operation (T1 time).

➤ Vanes adjustment time (x100ms)

This parameter lets introduce the time period for the vanes adjustment/blind movement (T2 time).

- When **"Value"** is selected the communication objects and new parameters for the Input "x" will appear as shown below.

➡ 110 Status\_In1 - Value [DPT\_5.010 - 1byte] - 1-byte unsigned value

> Function	Value
> Send telegram after bus recovery	Fixed value
> Sending delay after bus recovery (seconds)	10
> DPT to be sent	DPT 5.010 (1byte)
> Value on raising edge (when contact activated)	234

Figure 4.59 Parameter detail

➤ Send telegram after bus recovery

This parameter lets select if the Binary Input "x" will send a telegram, or not, after a bus recovery and the type of telegram sent (if enabled).

- When **"No action"** is selected, No telegram will be sent after a bus recovery.
- When **"Fixed value"** is selected, the binary input will send a telegram with the same value configured in the "Value on rising edge" parameter. Also a new parameter will appear (see below).

> Sending delay after bus recovery (seconds)	10
--	----

Figure 4.60 Parameter detail

➤ Sending delay after a bus recovery (seconds)

This parameter lets configure a delay (in seconds) that will be applied after a bus recovery and, after which, a telegram will be sent.

➤ DPT to be sent

This parameter lets select the DPT type for the value that will be defined in the next parameter. This value will be sent on a rising edge (contact activated).

> DPT to be sent	DPT 12.001 (4byte)
------------------	--------------------

Figure 4.61 Parameter detail

➤ Value on rising edge (when contact activated)

This parameter lets define a value for the DTP type configured in the "DPT to be sent" parameter. This value will be sent on a rising edge (contact activated).

- When **"Execute Scene (internal)"** is selected, the binary input "x" will activate the scene defined in the next parameter, on a rising edge (contact activated).

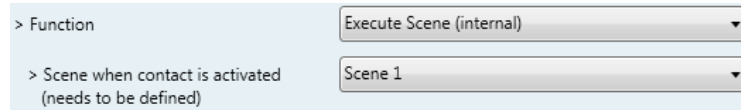

The screenshot shows a configuration dialog with two sections. The first section is labeled '> Function' and contains a dropdown menu with the selected option 'Execute Scene (internal)'. The second section is labeled '> Scene when contact is activated (needs to be defined)' and contains a dropdown menu with the selected option 'Scene 1'.

Figure 4.62 Parameter detail

➤ Scene when contact is activated

This parameter lets choose the scene that will be activated on a rising edge. This scene MUST be defined in the "Scene Configuration" dialog as a preset.

- When "**Occupancy (internal)**" is selected, the binary input "x" will have the same behavior as configured in the parameter "Enable use of Occupancy function" inside the "Switch-Off Timeouts Configuration" dialog.

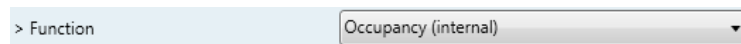

The screenshot shows a configuration dialog with one section labeled '> Function' containing a dropdown menu with the selected option 'Occupancy (internal)'.

Figure 4.63 Parameter detail

- When "**Window Contact (internal)**" is selected, the binary input "x" will have the same behavior as configured in the parameter "Enable use of Open Window / Switch off timeout function" inside the "Switch-Off Timeouts Configuration" dialog.



The screenshot shows a configuration dialog with one section labeled '> Function' containing a dropdown menu with the selected option 'Window Contact (internal)'.

Figure 4.64 Parameter detail

## 5 Specifications

<b>Enclosure</b>	ABS (UL 94 HB). 2,5 mm thickness
<b>Dimensions</b>	70 X 70 X 28 mm
<b>Weight</b>	70g
<b>Colour</b>	Ivory white
<b>Power supply</b>	29V DC, 7mA Supplied through KNX bus.
<b>AC Indoor Unit Bus</b>	Voltage: 13-18V Current: 80mA
<b>LED indicators</b>	1 x KNX programming.
<b>Push buttons</b>	1 x KNX programming.
<b>Binary inputs</b>	4 x Potential-free binary inputs. Signal cable length: 5m unshielded, may be extended up to 20m with twisted. Compliant with the following standards: IEC61000-4-2 : level 4 - 15kV (air discharge) - 8kV (contact discharge) MIL STD 883E-Method 3015-7 : class3B
<b>Configuration</b>	Configuration with ETS.
<b>Operating Temperature</b>	From -25°C to 85°C
<b>Storage Temperature</b>	From - 40°C to 45°C
<b>Isolation Voltage</b>	2500V
<b>RoHS conformity</b>	Compliant with RoHS directive (2002/95/CE).
<b>Certifications</b>	CE conformity to EMC directive (2004/108/EC) and Low-voltage directive (2006/95/EC)  <ul style="list-style-type: none"> <li>• EN 61000-6-2</li> <li>• EN 61000-6-3</li> <li>• EN 60950-1</li> <li>• EN 50491-3</li> <li>• EN 50090-2-2</li> <li>• EN 50428</li> <li>• EN 60669-1</li> <li>• EN 60669-2-1</li> </ul>

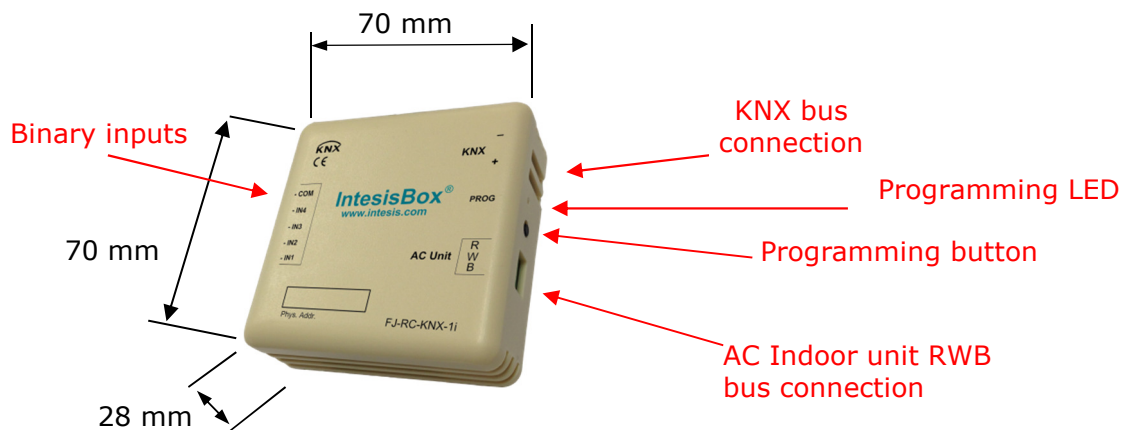

## 6 AC Unit Types compatibility

A list of FGL indoor unit model references compatible with FJ-RC-KNX-1i and their available features can be found in:

### Fujitsu:

[https://www.intesisbox.com/intesis/support/compatibilities/IntesisBox\\_FJ-RC-xxx-1\\_AC\\_Compatibility.pdf](https://www.intesisbox.com/intesis/support/compatibilities/IntesisBox_FJ-RC-xxx-1_AC_Compatibility.pdf)

### General:

[https://www.intesisbox.com/intesis/support/compatibilities/IntesisBox\\_GE-RC-xxx-1\\_AC\\_Compatibility.pdf](https://www.intesisbox.com/intesis/support/compatibilities/IntesisBox_GE-RC-xxx-1_AC_Compatibility.pdf)

### Fuji Electric:

[https://www.intesisbox.com/intesis/support/compatibilities/IntesisBox\\_FE-RC-xxx-1\\_AC\\_Compatibility.pdf](https://www.intesisbox.com/intesis/support/compatibilities/IntesisBox_FE-RC-xxx-1_AC_Compatibility.pdf)

### Hiyasu:

[https://www.intesisbox.com/intesis/support/compatibilities/IntesisBox\\_HY-RC-xxx-1\\_AC\\_Compatibility.pdf](https://www.intesisbox.com/intesis/support/compatibilities/IntesisBox_HY-RC-xxx-1_AC_Compatibility.pdf)

## 7 Error Codes

In order to get the right values regarding AC error codes, remember that you have to select the proper AC system type. Please visit section 4.1.2 for more information on the AC system type selection.

AC System Type	Error Type	Error section
RAC Non inverter models RAC inverter models	Type A	7.1
VRF V / S / J	Type A	7.2
RAC inverter model G* series VRF J-II / V-II / VR-II	Type B	7.1

\* G series stands for units that include a 'G' just before the power number in its reference.  
E.g.: ASYG09LTCA

### 7.1 RAC and VRF J-II / V-II / VR-II series

Error in KNX	Error in Remote Controller	Error Description	AC System Type
-1	NA	Communication Error (Hex:FFFF, Dec:65535)	RAC Inverter and Non Inverter
0	00	Wired remote controller error	
1	01	Indoor signal error	
2	02	Indoor room temperature sensor error	
3	03	Indoor room temperature sensor error	
4	04	Indoor heat exchanger temperature sensor (middle) error	
5	05	Indoor heat exchanger temperature sensor (middle) error	
6	06	Outdoor heat exchanger temperature sensor (outlet) error	
7	07	Outdoor heat exchanger temperature sensor (outlet) error	
8	08	Power voltage error	
9	09	Float switch operated	
10	0A	Outdoor temperature sensor error	
11	0b	Outdoor temperature sensor error	
12	0C	Outdoor discharge pipe temperature sensor error	
13	0d	Outdoor discharge pipe temperature sensor error	
14	0E	Heat sink thermistor (Inverter) error	
15	0F	Discharge temperature error	
17	11	Indoor unit EEPROM error	
18	12	Indoor fan error	
19	13	Indoor signal error	
20	14	Outdoor EEPROM error	
21	15	Compressor temperature sensor error	
22	16	Pressure switch abnormal, Pressure sensor error	
23	17	IPM protection	
24	18	CT error	
25	19	Active filter error	
		INV voltage protection	
26	1A	Compressor location error	
27	1b	Outdoor fan error	
28	1C	Outdoor unit computer communication error	
29	1d	2-way valve temperature sensor error	
30	1E	3-way valve temperature sensor error	
31	1F	Connected indoor unit error	
32	20	Indoor MANUAL AUTO switch error	
33	21	reverse VDD permanent stop protection	
34	22	VDD permanent stop protection	
36	24	Excessive high pressure protection on cooling	
37	25	P.F.C. circuit error	
38	26	Indoor signal error	
39	27	Indoor signal error	
40	28	Indoor heat exchanger temperature sensor (inlet) error	
41	29	Outdoor heat exchanger temperature sensor (middle) error	
42	2A	Power supply frequency detection error	
43	2b	Compressor temperature error	
44	2C	4-way valve error	
45	2d	Heat sink thermistor P.F.C. error	
46	2E	Indoor unit damper error	
		Inverter error	
47	2F	Low pressure error	
48	30	Refrigerant circuit address set-up error	
49	31	Master unit, Slave unit set-up error	

50	32	Connected the indoor number set-up error
51	33	P.F.C. printed circuit board error
52	34	Indoor fan 2 error
53	35	Control box thermistor error
54	36	Indoor unit CT error
55	37	Indoor fan motor 1 driving circuit error
56	38	Indoor fan motor 2 driving circuit error
117	11	Serial communication error between indoor/outdoor units
118	12	Remote controller communication error
119	13	Communication error between outdoor units
120	14	Network communication error
121	15	Scan error
122	16	Peripheral unit communication error
123	17	Electricity charge apportionment error
133	21	Indoor unit initial setting error
134	22	Indoor unit capacity abnormal
135	23	Incompatible series connection error
136	24	Connection unit number error
137	25	Connection pipe length error
138	26	Indoor unit address setting error
139	27	Master/slave unit setting error
140	28	Other setting error
141	29	Connection unit number error in wired remote controller system
149	31	Indoor unit power supply abnormal
150	32	Indoor unit main PCB error
151	33	Indoor unit display PCB error
152	34	Power relay error
153	35	Indoor unit manual auto switch error
154	36	Heater relay error
155	37	Indoor unit transmission PCB error
156	38	Network convertor PCB error
157	39	Indoor unit power supply circuit error
158	3A	Indoor unit communication circuit (wired remote controller) error
165	41	Indoor unit room temp. thermistor error
166	42	Indoor unit heat ex. temp. thermistor error
167	43	Humidity sensor error
168	44	Light sensor error
169	45	Gas sensor error
170	46	Float sensor error
171	47	Water temperature sensor error
172	48	Warm water flow rate sensor error
173	49	Heater sensor error
181	51	Indoor unit fan motor 1 error
182	52	Indoor unit coil (expansion valve) error
183	53	Indoor unit water drain abnormal
184	54	Air cleaning function error
185	55	Filter cleaning function error
186	56	Water circulation pump error
187	57	Indoor unit damper error
188	58	Indoor unit intake grille position error
189	59	Indoor unit fan motor 2 error
195	5U	Indoor unit miscellaneous error
197	61	Outdoor unit power supply abnormal
198	62	Outdoor unit main PCB error
199	63	Outdoor unit inverter PCB error
200	64	Outdoor unit active filter/PFC circuit error
201	65	Outdoor unit IPM error
202	66	Convertor distinction error
203	67	Outdoor unit power short interruption error (protective operation)
204	68	Outdoor unit magnetic relay error
205	69	Outdoor unit transmission PCB error
206	6A	Outdoor unit display PCB error
213	71	Outdoor unit discharge temp. thermistor error
214	72	Outdoor unit compressor temp. thermistor error
215	73	Outdoor unit heat ex. temp. thermistor error
216	74	Outside air temp. thermistor error
217	75	Outdoor unit suction gas temp. thermistor error
218	76	Outdoor unit operating valve thermistor error
219	77	Outdoor unit heat sink temp. thermistor error
220	78	Expansion valve temperature sensor error
229	81	Receiver liquid level detection sensor error
230	82	Outdoor unit sub-cool heat ex. gas temp. thermistor error
231	83	Outdoor unit liquid pipe temp. thermistor error
232	84	Outdoor unit current sensor error
233	85	Fan motor current sensor error
234	86	Outdoor unit pressure sensor error
235	87	Oil sensor error
245	91	Outdoor unit compressor 1 error
246	92	Outdoor unit compressor 2 error
247	93	Outdoor unit compressor start up error
248	94	Outdoor unit trip detection

**RAC**  
Inverter models G series

**VRF**  
J-II / V-II / VR-II Series

249	95	Outdoor unit compressor motor control error	RAC Inverter models G series
250	96	Open loop error(Field-weakening relevant)	
251	97	Outdoor unit fan motor 1 error	
252	98	Outdoor unit fan motor 2 error	
253	99	Outdoor unit 4-way valve error	
254	9A	Outdoor unit coil (expansion valve) error	
259	9U	Outdoor unit miscellaneous error	
261	A1	Outdoor unit discharge temperature 1 error	
262	A2	Outdoor unit discharge temperature 2 error	
263	A3	Outdoor unit compressor temperature error	
264	A4	Outdoor unit pressure error 1	
265	A5	Outdoor unit pressure error 2	
266	A6	Outdoor unit heat exchanger temperature error	
267	A7	Suction temperature abnormal	
268	A8	Poor refrigerant circulation	
269	A9	Current overload error	
270	AA	Outdoor unit special operation error	
271	AC	Ambient temperature error	
272	AF	Out of the possible operation range	
273	AJ	Freeze protection operated	
277	C1	Peripheral unit main PCB error	
278	C2	Peripheral unit transmission PCB error	
279	C3	Peripheral unit PCB 1 error	
280	C4	PCB 2 error	
281	C5	PCB 3 error	
282	C6	PCB 4 error	
283	C7	PCB 5 error	
284	C8	Peripheral unit input device error	
285	C9	Display device error	
286	CA	EEPROM error	
287	CC	Peripheral unit sensor error	
288	CF	Peripheral unit external connector error (USB memory)	
289	CJ	Other parts error	
293	F1	System tool software error	
294	F2	System tool adaptor error	
295	F3	System tool interface error	
296	F4	System tool environment error	
309	J1	RB unit error	
310	J2	Branch boxes error	
311	J3	Total heat exchanging, ventilation unit error	
312	J4	Domestic hot water unit error	
313	J5	Zone control interface error	
			VRF J-II / V-II / VR-II Series

## 7.2 VRF V / S / J series

Error in KNX	Error in Remote Controller	Error Description	
-1	NA	Communication Error (Hex:FFFF, Dec:65535)	VRF V / S / J series
0	00	No Error	
2	02	Model information Error	
4	04	Power frequency Error	
6	06	EEPROM access Error	
7	07	EEPROM deletion Error	
9	09	Room sensor Error	
10	0A	Heat Ex. Middle Sensor Error	
11	0b	Heat Ex. Inlet sensor Error	
12	0C	Heat Ex. Outlet sensor Error	
13	0d	Blower temperature thermistor Error	
17	11	Drain Error	
18	12	Room temperature Error	
19	13	Indoor fan motor Error	
20	18	Standard wired remote Error Standard wired token Error	
31	1F	Network communication Error	
32	20	Node setting error	
33	21	Communication Error between Main PCB & Transmission PCB	
34	32	Outdoor unit Error	

In case you detect an error code not listed in any of the different tables above, please contact your nearest FGL technical support service.

## 8 Appendix A – Communication Objects Table

TOPIC	OBJECT NUMBER	NAME	LENGTH	DATAPOINT TYPE		FLAGS				FUNCTION
				DPT_NAME	DPT_ID	R	W	T	U	
On/Off	0	Control_ On/Off	1 bit	DPT_Switch	1.001		W	T		0 - Off; 1-On
Mode	1	Control_ Economy	1 bit	DPT_Bool	1.002		W	T		1 - Set ECONOMY
	2	Control_ Mode	1 byte	DPT_HVACContrMode	20.105		W	T		0 - Auto; 1 - Heat; 3 - Cool; 9 - Fan; 14 - Dry
	3	Control_ Mode Cool/Heat	1 bit	DPT_Heat/Cool	1.100		W	T		0 - Cool; 1 - Heat;
	4	Control_ Mode Cool & On	1 byte	DPT_Scaling	5.001		W	T		0% - Off; 0.1%-100% - On + Cool
	5	Control_ Mode Heat & On	1 byte	DPT_Scaling	5.001		W	T		0% - Off; 0.1%-100% - On + Heat
	6	Control_ Mode Auto	1 bit	DPT_Bool	1.002		W	T		1 - Auto
	7	Control_ Mode Heat	1 bit	DPT_Bool	1.002		W	T		1 - Heat
	8	Control_ Mode Cool	1 bit	DPT_Bool	1.002		W	T		1 - Cool
	9	Control_ Mode Fan	1 bit	DPT_Bool	1.002		W	T		1 - Fan
	10	Control_ Mode Dry	1 bit	DPT_Bool	1.002		W	T		1 - Dry
	11	Control_ Mode +/-	1 bit	DPT_Step	1.007		W			0 - Decrease; 1 - Increase
	Control_ Mode +/-	1 bit	DPT_UpDown	1.008		W			0 - Up; 1 - Down	
Fan Speed	12	Control_ Fan Speed / 3 Speeds	1 byte	DPT_Scaling	5.001		W	T		0%-49% - Speed 1; 50%-82% - Speed 2; 83%-100% - Speed 3
		Control_ Fan Speed / 3 Speeds	1 byte	DPT_Enumerated	5.010		W	T		1 - Speed 1; 2 - Speed 2; 3 Speed 3
		Control_ Fan Speed / 4 Speeds	1 byte	DPT_Scaling	5.001		W	T		0%-37% - Speed 1; 38%-62% - Speed 2; 63%-87% - Speed 3; 88%-100% - Speed 4

Fan Speed		Control_ Fan Speed / 4 Speeds	1 byte	DPT_Enumerated	5.010		W	T	1 - Speed 1; 2 - Speed 2; 3 Speed 3; 4 Speed 4
	<b>13</b>	Control_ Fan Speed Man/Auto	1 bit	DPT_Bool	1.002		W	T	0 - Manual; 1 - Auto
	<b>14</b>	Control_ Fan Speed 1	1 bit	DPT_Bool	1.002		W	T	1 - Set Fan Speed 1
	<b>15</b>	Control_ Fan Speed 2	1 bit	DPT_Bool	1.002		W	T	1 - Set Fan Speed 2
	<b>16</b>	Control_ Fan Speed 3	1 bit	DPT_Bool	1.002		W	T	1 - Set Fan Speed 3
	<b>17</b>	Control_ Fan Speed 4	1 bit	DPT_Bool	1.002		W	T	1 - Set Fan Speed 4
	<b>18</b>	Control_ Fan Speed +/-	1 bit	DPT_Step	1.007		W		0 - Decrease; 1 - Increase
Control_ Fan Speed +/-		1 bit	DPT_UpDown	1.008		W		0 - Up; 1 - Down	
Vanes Up-Down	<b>19</b>	Control_ Vanes U-D / 4 pos	1 byte	DPT_Scaling	5.001		W	T	0%-37% - Pos1; 38%-62% - Pos2; 63%-87% Pos3; 88%-100% - Pos4
		Control_ Vanes U-D / 4 pos	1 byte	DPT_Enumerated	5.010		W	T	1 - Pos1; 2 - Pos2; 3 - Pos3; 4 - Pos4
	<b>20</b>	Control_ Vanes U-D Pos1	1 bit	DPT_Bool	1.002		W	T	1 - Set Position 1
	<b>21</b>	Control_ Vanes U-D Pos2	1 bit	DPT_Bool	1.002		W	T	1 - Set Position 2
	<b>22</b>	Control_ Vanes U-D Pos3	1 bit	DPT_Bool	1.002		W	T	1 - Set Position 3
	<b>23</b>	Control_ Vanes U-D Pos4	1 bit	DPT_Bool	1.002		W	T	1 - Set Position 4
	<b>24</b>	Control_ Vanes U-D Swing	1 bit	DPT_Bool	1.002		W	T	0 - Off; 1 - Swing
	<b>25</b>	Control_ Vanes U-D +/-	1 bit	DPT_Step	1.007		W		0 - Decrease; 1 - Increase
		Control_ Vanes U-D +/-	1 bit	DPT_UpDown	1.008		W		0 - Up; 1 - Down
<b>26</b>	Control_ Vanes U-D Move Pos	1 bit	DPT_Step	1.017		W		0 - Move position; 1 - Move position	
Vanes Left-Right	<b>27</b>	Control_ Vanes L-R / 5 pos	1 byte	DPT_Scaling	5.001		W	T	0%-29% - Pos1; 30%-49% - Pos2; 50%-69% Pos3; 70%-89% - Pos4; 90%-100% - Pos5
		Control_ Vanes L-R / 5 pos	1 byte	DPT_Enumerated	5.010		W	T	1 - Pos1; 2 - Pos2; 3 - Pos3; 4 - Pos4; 5 - Pos5

	<b>28</b>	Control_ Vanes L-R Pos1	1 bit	DPT_Bool	1.002		W	T	1 - Set Position 1
	<b>29</b>	Control_ Vanes L-R Pos2	1 bit	DPT_Bool	1.002		W	T	1 - Set Position 2
	<b>30</b>	Control_ Vanes L-R Pos3	1 bit	DPT_Bool	1.002		W	T	1 - Set Position 3
	<b>31</b>	Control_ Vanes L-R Pos4	1 bit	DPT_Bool	1.002		W	T	1 - Set Position 4
	<b>32</b>	Control_ Vanes L-R Pos5	1 bit	DPT_Bool	1.002		W	T	1 - Set Position 5
	<b>33</b>	Control_ Vanes L-R Swing	1 bit	DPT_Bool	1.002		W	T	0 - Off; 1 - Swing
	<b>34</b>	Control_ Vanes L-R +/-	1 bit	DPT_Step	1.007		W		0 - Decrease; 1 - Increase
		Control_ Vanes L-R +/-	1 bit	DPT_UpDown	1.008		W		0 - Up; 1 - Down
<b>35</b>	Control_ Vanes L-R Move Pos	1 bit	DPT_Step	1.007		W		0 - Move position; 1 - Move position	
<b>Temperature</b>	<b>36</b>	Control_ Setpoint Temperature	2 byte	DPT_Value_Temp	9.001		W	T	(°C)
	<b>37</b>	Control_ Setpoint Temp +/-	1 bit	DPT_Step	1.007		W		0 - Decrease; 1 - Increase
		Control_ Setpoint Temp +/-	1 bit	DPT_UpDown	1.008		W		0 - Up; 1 - Down
	<b>38</b>	Control_ Ambient Temp	2 byte	DPT_Value_Temp	9.001		W	T	(°C)
<b>Timeout</b>	<b>39</b>	Control_ Window Contact Status	1 bit	DPT_OpenClose	1.009		W	T	0 - Open; 1 - Closed
		Control_ Switch Off Timeout	1 bit	DPT_Start	1.010		W	T	0 - Stop; 1 - Start
	<b>40</b>	Control_ Occupancy	1 bit	DPT_Occupancy	1.018		W	T	0 - Not Occupied; 1 - Occupied
	<b>41</b>	Control_ Sleep Timeout	1 bit	DPT_Start	1.010		W	T	0 - Stop; 1 - Start
<b>Locking</b>	<b>42</b>	Control_ Lock Remote Control	1 bit	DPT_Bool	1.002		W	T	0 - Unlocked; 1 - Locked
	<b>43</b>	Control_ Lock Control Objects	1 bit	DPT_Bool	1.002		W	T	0 - Unlocked; 1 - Locked
<b>Special Modes</b>	<b>44</b>	Control_ Power Mode	1 bit	DPT_Start	1.010		W	T	0 - Stop; 1 - Start
	<b>45</b>	Control_ Econo Mode	1 bit	DPT_Start	1.010		W	T	0 - Stop; 1 - Start

	<b>46</b>	Control_ Additional Heat	1 bit	DPT_Start	1.010		W	T	0 - Stop; 1 - Start
	<b>47</b>	Control_ Additional Cool	1 bit	DPT_Start	1.010		W	T	0 - Stop; 1 - Start
<b>Scenes</b>	<b>48</b>	Control_ Save	1 byte	DPT_SceneControl	18.001		W	T	128 to 132 - Save Scene 1 to 5
		Control_ Exec Scene	1 byte	DPT_SceneControl	18.001		W	T	0 to 4 - Exec. Scene 1 to 5;
	<b>49</b>	Control_ Store Scene1	1 bit	DPT_Bool	1.002		W		1 - Store Scene
	<b>50</b>	Control_ Store Scene2	1 bit	DPT_Bool	1.002		W		1 - Store Scene
	<b>51</b>	Control_ Store Scene3	1 bit	DPT_Bool	1.002		W		1 - Store Scene
	<b>52</b>	Control_ Store Scene4	1 bit	DPT_Bool	1.002		W		1 - Store Scene
	<b>53</b>	Control_ Store Scene5	1 bit	DPT_Bool	1.002		W		1 - Store Scene
	<b>54</b>	Control_ Execute Scene1	1 bit	DPT_Bool	1.002		W	T	1 - Execute Scene
	<b>55</b>	Control_ Execute Scene2	1 bit	DPT_Bool	1.002		W	T	1 - Execute Scene
	<b>56</b>	Control_ Execute Scene3	1 bit	DPT_Bool	1.002		W	T	1 - Execute Scene
	<b>57</b>	Control_ Execute Scene4	1 bit	DPT_Bool	1.002		W	T	1 - Execute Scene
	<b>58</b>	Control_ Execute Scene5	1 bit	DPT_Bool	1.002		W	T	1 - Execute Scene
<b>Disabling</b>	<b>59</b>	Control_ Disable Input 1	1 bit	DPT_Bool	1.002		W	T	0 - False; 1 - True
		Control_ Disable Input 1	1 bit	DPT_Enable	1.003		W	T	0 - Disable; 1 - Enable
	<b>60</b>	Control_ Disable Input 2	1 bit	DPT_Bool	1.002		W	T	0 - False; 1 - True
		Control_ Disable Input 2	1 bit	DPT_Enable	1.003		W	T	0 - Disable; 1 - Enable
	<b>61</b>	Control_ Disable Input 3	1 bit	DPT_Bool	1.002		W	T	0 - False; 1 - True
		Control_ Disable Input 3	1 bit	DPT_Enable	1.003		W	T	0 - Disable; 1 - Enable
	<b>62</b>	Control_ Disable Input 4	1 bit	DPT_Bool	1.002		W	T	0 - False; 1 - True
		Control_ Disable Input 4	1 bit	DPT_Enable	1.003		W	T	0 - Disable; 1 - Enable

<b>On/Off</b>	<b>64</b>	Status_ On/Off	1 bit	DPT_Switch	1.001	R		T	0 - Off; 1-On
<b>Mode</b>	<b>65</b>	Status_ Economy	1 bit	DPT_Bool	1.002	R		T	1 -Economy is active
	<b>66</b>	Status_ Mode	1 byte	DPT_HVACContrMode	20.105	R		T	0 - Auto; 1 - Heat; 3 - Cool; 9 - Fan; 14 - Dry
	<b>67</b>	Status_ Mode Cool/Heat	1 bit	DPT_Heat/Cool	1.100	R		T	0 - Cool; 1 - Heat
	<b>68</b>	Status_ Mode Auto	1 bit	DPT_Bool	1.002	R		T	1 - Auto
	<b>69</b>	Status_ Mode Heat	1 bit	DPT_Bool	1.002	R		T	1 - Heat
	<b>70</b>	Status_ Mode Cool	1 bit	DPT_Bool	1.002	R		T	1 - Cool
	<b>71</b>	Status_ Mode Fan	1 bit	DPT_Bool	1.002	R		T	1 - Fan
	<b>72</b>	Status_ Mode Dry	1 bit	DPT_Bool	1.002	R		T	1 - Dry
	<b>73</b>	Status_ Mode Text	14 byte	DPT_String_8859_1	16.001	R		T	ASCII String
<b>Fan Speed</b>	<b>74</b>	Status_ Fan Speed / 3 Speeds	1 byte	DPT_Scaling	5.001		W	T	33% - Speed 1; 67% - Speed 2; 100% - Speed 3;
		Status_ Fan Speed / 3 Speeds	1 byte	DPT_Enumerated	5.010		W	T	1 - Speed 1; 2 - Speed 2; 3 Speed 3;
		Status_ Fan Speed / 4 Speeds	1 byte	DPT_Scaling	5.001		W	T	25% - Speed 1; 50% - Speed 2; 75% - Speed 3; 100% - Speed 4
		Status_ Fan Speed / 4 Speeds	1 byte	DPT_Enumerated	5.010		W	T	1 - Speed 1; 2 - Speed 2; 3 Speed 3; 4 Speed 4
	<b>75</b>	Status_ Fan Speed Manual/Auto	1 bit	DPT_Bool	1.002	R		T	0 - Manual; 1 - Auto
	<b>76</b>	Status_ Fan Speed 1	1 bit	DPT_Bool	1.002	R		T	1 - Fan is in speed 1
	<b>77</b>	Status_ Fan Speed 2	1 bit	DPT_Bool	1.002	R		T	1 - Fan is in speed 2
	<b>78</b>	Status_ Fan Speed 3	1 bit	DPT_Bool	1.002	R		T	1 - Fan is in Speed 3
	<b>79</b>	Status_ Fan Speed 4	1 bit	DPT_Bool	1.002	R		T	1 - Fan is in Speed 4
<b>80</b>	Status_ Fan Speed Text	14 byte	DPT_String_8859_1	16.001	R		T	ASCII String	
<b>Vanes UP-Down</b>	<b>81</b>	Status_ Vanes U-D / 4 pos	1 byte	DPT_Scaling	5.001	R		T	25% - Pos1; 50% - Pos2; 75% - Pos3; 100% - Pos4

		Status_ Vanes U-D / 4 pos	1 byte	DPT_Enumerated	5.010	R	T	1 - Pos1; 2 - Pos2; 3 - Pos3; 4 - Pos4
	<b>82</b>	Status_ Vanes U-D Pos1	1 bit	DPT_Bool	1.002	R	T	1 - Position 1
	<b>83</b>	Status_ Vanes U-D Pos2	1 bit	DPT_Bool	1.002	R	T	1 - Position 2
	<b>84</b>	Status_ Vanes U-D Pos3	1 bit	DPT_Bool	1.002	R	T	1 - Position 3
	<b>85</b>	Status_ Vanes U-D Pos4	1 bit	DPT_Bool	1.002	R	T	1 - Position 4
	<b>86</b>	Status_ Vanes U-D Swing	1 bit	DPT_Bool	1.002	R	T	0 - Off; 1 - Swing
	<b>87</b>	Status_ Vanes U-D Text	14 byte	DPT_String_8859_1	16.001	R	T	ASCII String
<b>Vanes Left-Right</b>	<b>88</b>	Status_ Vanes L-R / 5 pos	1 byte	DPT_Scaling	5.001	R	T	20% - Pos1; 40% - Pos2; 60% - Pos3; 80% - Pos4; 100% - Pos5
		Status_ Vanes L-R / 5 pos	1 byte	DPT_Enumerated	5.010	R	T	1 - Pos1; 2 - Pos2; 3 - Pos3; 4 - Pos4; 5 - Pos5
	<b>89</b>	Status_ Vanes L-R Pos1	1 bit	DPT_Bool	1.002	R	T	1 - Position 1
	<b>90</b>	Status_ Vanes L-R Pos2	1 bit	DPT_Bool	1.002	R	T	1 - Position 2
	<b>91</b>	Status_ Vanes L-R Pos3	1 bit	DPT_Bool	1.002	R	T	1 - Position 3
	<b>92</b>	Status_ Vanes L-R Pos4	1 bit	DPT_Bool	1.002	R	T	1 - Position 4
	<b>93</b>	Status_ Vanes L-R Pos5	1 bit	DPT_Bool	1.002	R	T	1 - Position 5
	<b>94</b>	Status_ Vanes L-R Swing	1 bit	DPT_Bool	1.002	R	T	0 - Off; 1 - Swing
	<b>95</b>	Status_ Vanes L-R Text	14 byte	DPT_String_8859_1	16.001	R	T	ASCII String
<b>Temperature</b>	<b>96</b>	Status_ AC Setpoint Temp	2 byte	DPT_Value_Temp	9.001	R	T	(°C)
	<b>97</b>	Status_ AC Ambient Ref Temp	2 byte	DPT_Value_Temp	9.001	R	T	(°C)
<b>Error</b>	<b>98</b>	Status_ Error/Alarm	1 bit	DTP_Alarm	1.005	R	T	0 - No Alarm; 1 - Alarm

	<b>99</b>	Status_ Error Code	2 byte	Enumerated		R		T	0 - No Error; Any other see user's manual
	<b>100</b>	Status_ Error Text code	14 byte	DPT_String_8859_1	16.001	R		T	4 char FJ Error; Empty - None
<b>Locking</b>	<b>101</b>	Status_ Lock Remote Control	1 bit	DPT_Bool	1.002		W	T	0 - Unlocked; 1 - Locked
	<b>102</b>	Status_ Lock Remote Control Objects	1 bit	DPT_Bool	1.002		W	T	0 - Unlocked; 1 - Locked
<b>Special Modes</b>	<b>103</b>	Status_ Power Mode	1 bit	DPT_Switch	1.001	R		T	0 - Off; 1-On
	<b>104</b>	Status_ Econo Mode	1 bit	DPT_Switch	1.001	R		T	0 - Off; 1-On
	<b>105</b>	Status_ Additional Heat	1 bit	DPT_Switch	1.001	R		T	0 - Off; 1-On
	<b>106</b>	Status_ Additional Cool	1 bit	DPT_Switch	1.001	R		T	0 - Off; 1-On
<b>Counter</b>	<b>107</b>	Status_ Operation Hour Counter	2 byte	DPT_Value_2_Ucount	7.007	R		T	Number of operating hours
<b>Scene</b>	<b>108</b>	Status_ Current Scene	1 byte	DPT_SceneNumber	17.001	R		T	0 to 4 - Scene 1 to 5; 63 - No Scene
<b>Binary Inputs</b>	<b>109</b>	Status_ Inx - Switching	1 bit	DPT_Switch	1.001	R		T	0 - Off; 1-On
	<b>111</b>	Status_ Inx - Dimming - On/Off	1 bit	DPT_Switch	1.001	R		T	0 - Off; 1 - On
	<b>113</b>	Status_ Inx - Shut/Blind - Step	1 bit	DPT_ShutterBlinds	1.023	R		T	0 - Step Up; 1 - Step Down
	<b>110</b>	Status_ Inx - Value	1 byte	DPT_Value_1_Ucount	5.010	R		T	1 byte unsigned value
		Status_ Inx - Value	2 byte	DPT_Value_2_Ucount	7.001	R		T	2 byte unsigned value
		Status_ Inx - Value	2 byte	DPT_Value_2_Count	8.001	R		T	2 byte signed value
	<b>112</b>	Status_ Inx - Value	2 byte	DPT_Value_Temp	9.001	R		T	Temperature (°C)
	<b>114</b>	Status_ Inx - Value	4 byte	DPT_Value_4_Ucount	12.001	R		T	4 byte unsigned value
	<b>116</b>	Status_ Inx - Dimming - Step(%)	1 bit	DPT_Control_Dimm.	3.007	R		T	Dimming step
		Status_ Inx - Shut/Blind -Move	1 bit	DPT_ShutterBlinds	1.023	R		T	0 - Move Up; 1 - Move Down